

33
✓

<p>(51) International Patent Classification ⁶ : H04N 7/173</p>	<p>A1</p>	<p>(11) International Publication Number: WO 96/04753 (43) International Publication Date: 15 February 1996 (15.02.96)</p>
<p>(21) International Application Number: PCT/US95/09802 (22) International Filing Date: 1 August 1995 (01.08.95) (30) Priority Data: 08/284,846 2 August 1994 (02.08.94) US (71) Applicant: INTERIM DESIGN INC. [US/US]; 140 Clover Lane, Elizabethtown, PA 17022 (US). (72) Inventor: HADDAD, Joseph, C.; 140 Clover Lane, Elizabethtown, PA 17022 (US). (74) Agents: BARRESE, Rocco, S. et al.; Dilworth & Barrese, 333 Earle Ovington Boulevard, Uniondale, NY 11553 (US).</p>	<p>(81) Designated States: AM, AT, AU, BB, BG, BR, BY, CA, CH, CN, CZ, DE, DK, EE, ES, FI, GB, GE, HU, JP, KE, KG, KP, KR, KZ, LK, LR, LT, LU, LV, MD, MG, MN, MW, MX, NO, NZ, PL, PT, RO, RU, SD, SE, SG, SI, SK, TJ, TT, UA, UG, UZ, VN, European patent (AT, BE, CH, DE, DK, ES, FR, GB, GR, IE, IT, LU, MC, NL, PT, SE), OAPI patent (BF, BJ, CF, CG, CI, CM, GA, GN, ML, MR, NE, SN, TD, TG), ARIPO patent (KE, MW, SD, SZ, UG).</p> <p>Published <i>With international search report. Before the expiration of the time limit for amending the claims and to be republished in the event of the receipt of amendments.</i></p>	

(54) Title: AN INTERACTIVE AUDIOVISUAL DISTRIBUTION SYSTEM

(57) Abstract

A distribution center according to the present invention is capable of handling requests from a plurality of subscribers for accessing programs in a central audiovisual library. The subscriber requests may specify a variable time allowance interval within which a requested program may be delivered.

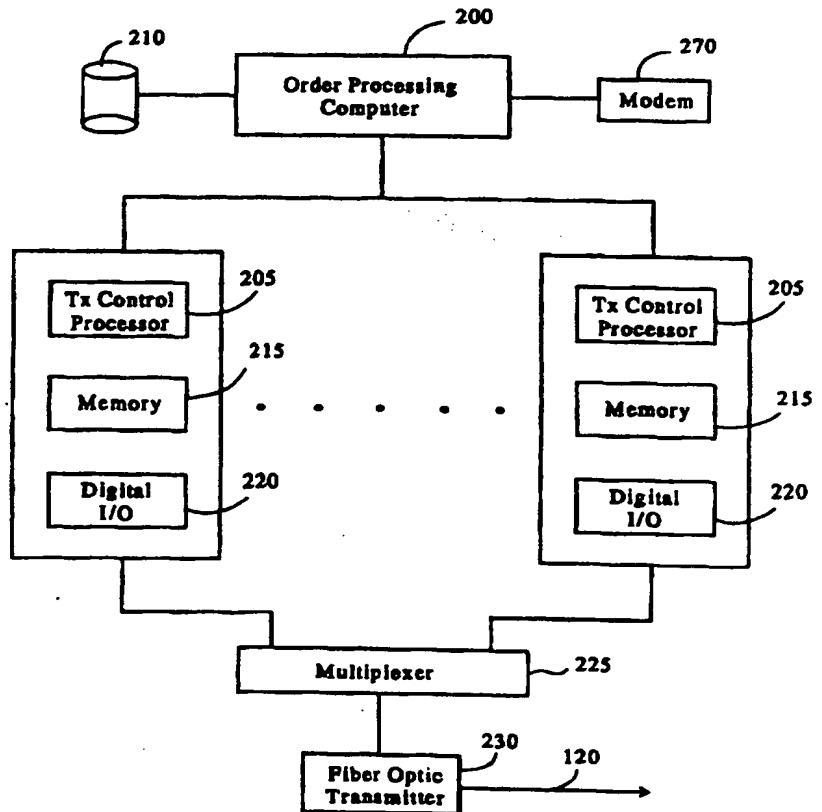

FOR THE PURPOSES OF INFORMATION ONLY

Codes used to identify States party to the PCT on the front pages of pamphlets publishing international applications under the PCT.

AT	Austria	GB	United Kingdom	MR	Mauritania
AU	Australia	GE	Georgia	MW	Malawi
BB	Barbados	GN	Guinea	NE	Niger
BE	Belgium	GR	Greece	NL	Netherlands
BF	Burkina Faso	HU	Hungary	NO	Norway
BG	Bulgaria	IE	Ireland	NZ	New Zealand
BJ	Benin	IT	Italy	PL	Poland
BR	Brazil	JP	Japan	PT	Portugal
BY	Belarus	KE	Kenya	RO	Romania
CA	Canada	KG	Kyrgystan	RU	Russian Federation
CF	Central African Republic	KP	Democratic People's Republic of Korea	SD	Sudan
CG	Congo	KR	Republic of Korea	SE	Sweden
CH	Switzerland	KZ	Kazakhstan	SI	Slovenia
CI	Côte d'Ivoire	LI	Liechtenstein	SK	Slovakia
CM	Cameroon	LK	Sri Lanka	SN	Senegal
CN	China	LU	Luxembourg	TD	Chad
CS	Czechoslovakia	LV	Latvia	TG	Togo
CZ	Czech Republic	MC	Monaco	TJ	Tajikistan
DE	Germany	MD	Republic of Moldova	TT	Trinidad and Tobago
DK	Denmark	MG	Madagascar	UA	Ukraine
ES	Spain	ML	Mali	US	United States of America
FI	Finland	MN	Mongolia	UZ	Uzbekistan
FR	France			VN	Viet Nam
GA	Gabon				

1

AN INTERACTIVE AUDIOVISUAL DISTRIBUTION SYSTEMBACKGROUND OF INVENTION1. Technical Field

5

The present invention relates to an interactive communication system that allows a plurality of subscribers to access a central audiovisual library, more specifically, a system capable of handling each subscriber's tailored requests for program segments.

10 2. Background of Related Art

Systems which provide subscriber access to prerecorded program segments from a distributor center have been described. For example, in a system described in Patent No. 4,521,806 to Abraham, a plurality of subscribers are able
15 independently to access segments of a central program library. The requested broadcast segments are digitized and time compressed at the central station. They are then delivered to the requesting subscriber only. The time compressed segments are recorded at the subscriber station by
20 a two-speed recorder. When the transmission of the requested segment is complete, a broadcast signal attached to the end of the broadcast segment causes the two-speed recorder at the subscriber station to playback immediately the transmitted segment. In this system subscriber viewing time is a
25 function of the program delivery time.

In a system described in Patent No. 4,751,684 to Clark et. al., each system subscriber is able to request program segments from a distribution center. These segments are then delivered to all system subscribers
30 indiscriminately. Subscriber requests to the center are

35

1 placed in line in the chronological order in which they are
received, and are broadcast in turn on one common channel.

U.S. Patent No. 4,963,995 to Lang discloses a
video recorder/transmitter apparatus that enables a user to
5 receive, compress, edit, and retransmit video program
information in either compressed or decompressed format. The
apparatus includes memory for mass data storage. The patent
proposes the linkage of a plurality of the apparatus to a
network transfer system, with one apparatus acting as a
10 distribution center. The above-mentioned U.S. Patent Nos.
4,521,806; 4,751,684; and 4,963,995 are incorporated herein
by reference.

Other recent audiovisual delivery systems
include pay-per-view (PPV) and video-on-demand. Both systems
15 offer real time or near instantaneous delivery of subscriber
requested video programs in exchange for fees. Both systems
emulate an on premise or home video store. But different
from a video program rented from a video store, a drawback of
these systems is the inability of the subscriber to
20 manipulate the video program, such as rewind, pause, fast
forward, etc., while it is being played or delivered.
Further, the fees charged to the subscriber requesting the
video program are based on the amount of time the subscriber
accesses or is on the system. In contrast, a user who rents
25 video programs from a video store may choose to access the
program as many times and whenever he chooses without
incurring further charges.

Therefore, there exists a need for an
audiovisual delivery system that is efficient for the program
30

1 distributor while accommodating the individual needs of each
subscriber. More particularly, a system capable of handling
subscriber requests of several time allowance intervals
within which program segments will be delivered. The program
5 distributor accumulates like orders and has the option and
capability to fill each of these like orders simultaneously.
The subscriber is subsequently able to manipulate and view
segments or an entire delivered program.

10 SUMMARY OF THE INVENTION

To achieve these goals the system according to
the present invention provides for subscribers not only to
have unlimited access to a program library, but also to
select variable time allowance intervals for each program
15 requested. The subscriber is not choosing "yes" or "no" to
predetermined times of the day for delivery, as in PPV
systems. Instead, by choosing a variable time allowance
interval, (s)he is indicating the minimum and maximum amount
of time (s)he will wait for the deliver of a request, with
20 those minimums and maximums dependent upon, and beginning
with, the time that a request is placed.

The system according to the present invention
allows a plurality of subscribers to select any recorded
program of a central audiovisual library, without the
25 constraints of a central broadcast menu preselected by the
distributor. The system further allows a subscriber to
receive and store his selection(s), and to view them
subsequently at any time he chooses. Independent viewing by
each subscriber is made possible by linking a temporary
30

1 storage unit with a microprocessor and keypad at each
subscriber location. With microprocessor control of the
temporary storage unit, the system further allows for a
predetermined amount of time that a program request can be
5 viewed by a subscriber, that amount to be determined by the
subscriber or the system distributor.

An object of the system according to the
present invention is to allow for off-peak delivery of
requested programs. The present invention addresses the
10 issues of affordability, efficiency, and subscriber appeal.
In most audio-visual distribution systems the greatest
consumer demand occurs in the early evening hours. This peak
demand taxes the distribution network and may cause
distributors to limit consumer choices. The present
15 invention allows the distributor to shift much of the demand
away from the peak hours without limiting the consumer to a
pre-set or limited menu of programs.

In the present invention the distributor
provides the subscriber with several variable time allowance
20 intervals for delivery of requested programs. For example,
the distributor can offer "express delivery", that is, within
one hour; "one day delivery:", that is within a twenty-four
hour period; or "long term delivery", within seven (7) days.
Each time allowance interval is defined by the maximum amount
25 of time it will take for the order to be filled. Longer term
time frames can allow a minimum of time to elapse before
delivery. For example, the seven (7) day time frame can be
structured so that the program segments will be delivered
before the end of seven days, but not before a specified

30

-4-

35

1 time, for example, twenty-five (25) hours. In this way, the
subscriber can anticipate his or her future program
selections and place them at a much earlier date without
prematurely burdening his own storage capabilities. The
5 system of the invention also allows the subscriber to waive
the minimum time before delivery in those instances where his
own storage capacity would not be overburdened. If the
subscriber, for example, chooses a seven (7) day delivery
service, he can waive the twenty-five (25) hours delivery
10 minimum and receive delivery anytime within seven (7) days.
The subscriber will choose which of these time frames meets
his needs on any given occasion. Product prices will vary
accordingly. Pricing strategies will encourage distribution
during off-peak hours and thereby utilize the system hardware
15 more fully. Not all program segments need to be available
for each interval.

Another object of the present invention is to
allow identical orders to accumulate within a given time
period. The distributor has the option and the capability of
20 delivering simultaneously all or several requests for the
same program segment as long as there is some overlapping
time period for the associated time allowance intervals as
defined by the various requests. The feature of allowing
order accumulation provides maximum efficiency and
25 flexibility for the distributor. The distributor is able to
use the variability of the time intervals as a basis to
employ an optimization strategy. The advantages derived from
the optimization include a lower overall cost.

30

-5-

35

1 Still another object of the present invention
is to provide viewing time independent of transmission
(delivery) time. The system described herein enables the
subscriber to order and store one or more program segments.
5 At any time after transmission, the subscriber can view the
program segment entirely or in part. The number of viewing
times may be limited to a predetermined number, except in
those cases where the subscriber has purchased the program
segment through the system.

10

BRIEF DESCRIPTION OF THE DRAWINGS

Other objects, features and advantages of the
present invention will become more readily apparent from the
following detailed description of the preferred embodiments
15 and the accompanying drawings:

Figure 1 illustrates the audiovisual
distribution system according to the present invention;

Figure 2 shows the major component of the
distribution center;

20 Figure 3 shows the major components of a
subscriber terminal;

Figures 4 and 5 are a flow diagram of an order
processing module;

25 Figure 6 and 7 are a flow diagram of a
feasibility scheduling module;

Figure 8 is a flow diagram of a delete order
module;

Figure 9 is a flow diagram of an optimal
scheduling module;

30

-6-

35

1 Figure 10 is a flow diagram of a transmit
module;

 Figure 11 shows flow diagrams for a start-up
module and receive module;

5 Figure 12 shows a flow diagram of a request
module;

 Figures 13 and 14 show a flow diagram of a
process order module;

 Figure 15 is a flow diagram of a select view
10 module; and

 Figure 16 is a flow diagram of a view module.

DETAILED DESCRIPTION OF THE PREFERRED EMBODIMENTS

 Briefly, the system according to the present
15 invention preferably utilizes a compressed digital video
technology to provide for transmission of full motion video
programs from a central distribution center to individual
subscribers which are connected over a communication network.

 The system provides high speed communications,
20 preferably 1.544 Mbits/sec or higher, to carry video program
segments from a distribution center 100 to a plurality of
subscribers 110. The system also provides a low speed bi-
directional communication link which can be used for
controlling the video transmission. The system can further
25 use high speed dial-up transmission with calls to subscribers
originating from the telephone switching center. Permanently
connected links are also contemplated.

 The high speed link 120, is preferably an
optical fiber link for transmission of program data from the
30

1 distribution center 100. The high speed link 120 may
broadcast the same data to all subscribers, much the same as
existing CATV systems. The high speed link may also use
switching capabilities to facilitate services such as
5 conferencing. It is apparent to one skilled in the art that
other known communication techniques including wireless
communication can be implemented to accomplish the features
of the delivery system according to the present invention.
The low speed link 130 is preferably a communication link via
10 modems and dial-up telephone lines. It provides a duplex
(two-way) channel for order requests and confirmation. A
subscriber terminal 140 at each subscriber location is
configured to receive those programs that have been confirmed
through the order entry subsystem at the distribution center.
15 The transmission could be encoded to prevent unauthorized
reception. Unlike typical computer communication protocols,
there is no need for the subscriber terminal to acknowledge
whether a data packet has been received correctly.
Occasional transmission errors are not critical in full
20 motion video and would not be objectionable. The high speed
and the low speed links described above can be combined into
one link, such as the Bell System ADSL, for communicating the
aforementioned information via a single bi-directional link.
For order entry processing on the other hand,
25 the integrity of the transmitted data is extremely important,
and full two-way handshaking is preferred. The amount of
data in this case is moderate and relatively low speed. A
modem speed of 2400 baud is usually sufficient.

30

- 8 -

35

1 DISTRIBUTION CENTER

The distribution center 100 performs the following major functions:

1. Processes the incoming request for a
5 video program from a customer.
 - a) receive incoming calls and establish the
(low speed) communication link with a
Subscriber Terminal.
 - b) provide authorization for the subscriber
10 to receive and/or make a permanent copy
of the program.
2. Schedules the video program segments for
transmission and determine whether an incoming order can be
delivered at the requested variable time allowance interval.
- 15 3. Controls the transmission of the video
program segments.
4. Maintains customer information and
billing records.
5. Maintains the library and catalog of
20 video program segments.

The video programs are preferably available in compressed form and stored on an optical disk. Write Once-Read Many (WORM) or CD-Recordable technology can be used, with the disks stored in a jukebox arrangement. Manual
25 intervention may be necessary to assure that the required program disks are loaded in the jukebox as needed.

Video compression techniques are known. Applicable compression techniques for the present invention include DVI (Digital Video Interactive from Intel Corp.) and
30

1 the Compressed Digital Video (CDV) technology from
Compression Labs, Inc. For an average compression ratio of
about 160:1 for VCR quality moving images, a frame of video
512x480 pixels x 3 colors (720 KBytes) can be reduced to 5
5 KBytes/frame. With a 30 frames/sec rate, the compressed
video requires 150 KB/sec. For a 90 minute (5400 sec) video,
total storage required is about 810 MB. The CDV technology
has a somewhat better image quality but requires 1.5
Mbits/sec (188 KBytes/sec) resulting in a little over 1 BByte
10 for a 90 minute video. It is anticipated that with MPEG2,
high quality video could be provided at 3 to 5 Mbits/sec or
studio quality video at 7 to 10 Mbits/sec.

The system of the invention handles incoming
orders without interrupting the transmission of the video
15 programs. The distribution center includes multiple
processors for video transmission control. Preferably, each
processor transmits a separate video program. The
transmission scheme can be by ADSL, with a conference call
transmitting to multiple subscribers simultaneously.
20 Alternatively, the several programs can be time-division
multiplexed onto the optical fiber, providing better
utilization of the fiber capacity. In either case each
communication line may be serving subscribers in a particular
geographic area.

25 Order Processing

The Distribution Center includes an order
processing computer 200 which handles the communication with
the subscriber terminals over the low speed modem links 130,
processes incoming orders, and maintains the customer

30

-10-

35

1 information/billing data. Authorization to receive a
particular program or to make a permanent copy of a program
would be sent back to the subscriber terminals, along with
any encryption keys, if necessary, to decode the transmitted
5 program. The order processing computer 200 also determines a
schedule for transmitting the video programs and notifies the
transmission control processors 205 what programs to transmit
and when to transmit them. A display associated with the
order processing computer alerts an operator to load program
10 disks into the video library of the appropriate transmission
control processor.

The order processing computer 200 includes a
standard hard disk (not shown) for storage of customer
information and billing data as well as a catalog of video
15 programs. Depending on the number of subscribers and the
number of incoming orders anticipated, one or more additional
processors may be dedicated to handling telephone
communications and some of the order processing functions to
off-load the main order processing computer.

20 An interface bus, preferably IEEE-488
interface bus 215, links the transmission control processors
to the order processing computer for initiation of a video
program transmission and passing encryption keys. Several
transmission control processors can be connected on a single
25 IEEE-488, and more buses could be added as needed.

Video Transmission Control

The primary function of the transmission
control processors 205 is to retrieve video program data from
the video library 210, provide encryption or other receiver
30

1 authorization control, and transmit the data over the high
speed fiber link 120. The process of transmitting a program
is initiated on command from the scheduling function in the
order processing computer 200. Several transmission control
5 processors may be transmitting different video programs at
the same time using a time-division multiplexing scheme.

The video library 210 includes a set of WORM
optical disks or CD-Recordable disks that can be loaded into
a jukebox type disk reader. The memory 215, which may also
10 be a jukebox, can hold a number of disks and select the
appropriate one for access. The memory 215 holds over 1300
gigabytes of data and can be further expanded if necessary.
Other contemplated storage mediums include magnetic tape
systems that can automatically select and mount tape reels
15 from an extremely large archive library. A digital I/O board
220 is used to output the video data to the fiber optic
transmitter 230. This board provides for a transfer rate of
400 KBytes/sec with Direct Memory Access (DMA). At this data
rate, a 90 minute program can be transmitted in a little over
20 a half hour using DVI compression technology. The digital
I/O board may be a PDMA-32 which is commercially available
from Keithly-Metrabyte, or any substantially equivalent I/O
board having similar performance characteristics.

The capacity of the fiber optical link is in
25 the range of 270 Mbits/sec (33 MBytes/sec) to 1Gbit/sec (125
MBytes/sec). At the lower rate the link is capable of
handling about 80 different programs simultaneously. Using a
time division multiplexing scheme, packets from different
video programs would be intermixed on the fiber link under

30

-12-

35

1 control of multiplexing logic circuitry 225 interfacing the
several transmission control channels to fiber optic
transmitter 230. At the subscriber terminals, similar
demultiplexing logic circuitry would identify those packets
5 that a particular terminal was authorized to receive and
store them in a buffer memory, to be read in via the digital
I/O board.

The fiber optic transmitter 230 includes an
optical fiber transmitter/receiver module available from
10 Force, Inc., model #2666T-SCXX with data bandwidth of 50 Mb/s
to greater than 1 Gb/s at operating range 10 km to 20 km
(typical). The module connects to an Advanced Micro Devices
TAXI chip set (AM7968/AM7969) which in turn interfaces to the
multiplexor 225 described above. The multiplexor 225 can be
15 custom designed using the same technology as the TAXI chip
sets.

SUBSCRIBER TERMINAL

The major components of a subscriber terminal
20 110 are shown in Figure 3. A receiver 310 is connected to
the fiber optic link 120 for receiving the high speed optical
transmissions from the Distribution Center 100. The receiver
310 includes a photodiode for detecting the transmitted
optical data and converting the optical data to electrical
25 signals. A detector such as a Model #2666R-SCXX, available
from Force, Inc., is preferably used. The receiver 310 also
includes signal conditioning circuitry for reshaping the
detected signals. An AM 7969 TAXI chip, available from
Advanced Micro Devices, is preferably used.

30

35

1 A demultiplexer/decoder 320 demultiplexes the
received signals previously multiplexed by multiplexor 225 of
the Distribution Center 100 and digital I/O board 330
interfaces the demultiplexed data to the video and data
5 distribution circuitry, which includes a terminal processor
340, a video processor module 350 and memory 360. The
terminal processor 340 is preferably a personal computer (PC)
which includes associated display, modified keyboard
(keypad), hard disk memory, and/or WORM or CD-recordable
10 memory. The terminal processor 340 is also connected to
telephone link 130 through modem 370 for communicating with
the Distribution Center 100 including requesting and
receiving authorization for selected program segment orders.

Video processor 350 decompresses the video
15 data received from the digital I/O 330 and provides Red-
Green-Blue (RGB) video outputs and Hifi/stereo audio outputs.
The video processor 350 may be an Action Media 750 available
from Intel. The compressed video program data may be stored
on one or more magnetic hard disks for temporary storage and
20 a WORM or CD-Recordable disk for a permanent copy. If more
than one hard disk is used, a previously received program
could be viewed at the same time that a second program is
being received. To store three 90 minute video programs in
temporary storage, approximately 2.2 GBytes of memory are
25 required.

As an alternative to temporary storage of
video programs at the subscriber terminal, a pool of hard
disks located at the Distribution Center could provide real
time transmission. These disks would receive program

30

-14-

35

1 segments from the transmission control processors as
requested by subscribers.

Order entry may be selected through a menu
driven process using the PC keyboard and monitor. With this
5 approach the keypad would only need a set of number keys plus
an ENTER key. The subscriber terminal 110 dials up the
distribution center 100 to process orders and to receive the
authorization codes and/or encryption keys to receive the
program. The program would be stored on the magnetic disk,
10 and if authorization for permanent copy is received, it would
be copied to the WORM optical disk as convenient. Programs
could be copied from temporary to permanent storage only when
authorization is received from the order processing system.

DISTRIBUTION CENTER SOFTWARE

15 The software architecture for the Distribution
Center includes five primary processing modules and
preferably five databases. The processing modules are
loosely coupled and operate on an event-driven basis. They
perform the following general functions of: (1) Order
20 processing - processes the incoming request from a customer;
(2) Scheduling - schedules the video program segments for
transmission; (3) Transmit - controls the transmission of
the video program segments; (4) Customer
maintenance/billing - maintains customer information and
25 billing records; and (5) Library maintenance - maintain the
library and catalog of video program segments.

The databases are organized as follows:

1. Library - contains the currently
available video program segments in compressed format ready
30

- 1 for transmission. Each video program segment may be
contained on a separate WORM or CD-ROM disk arranged in a
jukebox type format.
2. Catalog - list of current titles in the
5 Library database, including pointers to the corresponding
library disk volume. For each entry, it contains the program
length, the price schedule for the various classes of
service, and recent statistics on customer demand (for use in
optimizing the transmission schedule).
- 10 3. Customer - contains customer information
and billing records plus passwords and other information
needed to authenticate customer identity on receipt of a
dial-in request.
4. Orders - current list of customer orders
15 to be delivered. Identifies the customer by a key into the
Customer database and the video segment by a key into the
Catalog database.
5. Schedule - current schedule of video
program segments to be transmitted. This database further
20 includes:
- a) Feasible schedule - used to determine
whether a requested delivery is possible.
It is organized by time slot and has each
video segment delivered at the last
25 possible moment to satisfy requested
variable time allowance intervals.
- b) Optimal schedule - an optimized schedule,
organized by hardware delivery channel,
showing the video segment currently being

30

-16-

35

1 transmitted (including start/end times,
etc.) and the next segment scheduled on
that channel.

Each entry includes receiver authorization
5 codes and keys into the Orders and Catalog databases.
A description of each module follows.

Order Processing

The Order Processing module provides the
interface by which the customer enters a request for a video
10 program segment. A representative flowchart of the order
processing module is shown in Figures 4 and 5 as follows:

On receiving an incoming phone call over a
modem (405), the call is answered and a NewOrder data object
is created (405) for processing this call. Note that several
15 instances of these data objects may exist at the same time as
simultaneous incoming requests are processed. The following
functions are performed for each NewOrder data object.

a) Validate the customer by retrieving the
customer ID information (410) and checking information in the
20 Customer database (415) and save the key into that database.
If the customer cannot be validated (420), send sign off
message and terminate call (430).

b) If this customer has an outstanding order
(435, 445), prompt over the modem phone link whether an
25 existing order is to be changed or a new order is to be
entered (450). If an order is to be changed (455), prompt
for the changes interactively and process them (steps 460 to
490). For any changes in variable time allowance interval,
the Scheduling module must be called to update the Feasible

30

35

1 Schedule (470) and, if a higher variable time allowance interval is requested, to determine whether the delivery is feasible.

5 c) Prompt the customer for a new order by interactively presenting the list of titles from the Catalog database; along with ordering instructions and pricing (510). If the customer enters an order (515), save the key into the Catalog database for that video program segment and proceed to the next step. Otherwise, go to confirmation and sign off
10 routine(s).

d) Invoke the Scheduling module to verify whether the video program segment can be scheduled in the variable time allowance interval that the customer requested. The Feasible Schedule is also updated at this time (520).

15 e) If the program segment cannot be scheduled for the requested variable time allowance interval, notify the customer of the highest variable time allowance interval that can be scheduled and ask whether that is acceptable (525, 530). If not acceptable (535), invoke the
20 Scheduling module to delete this order from the Feasible Schedule and go back to step 510 above.

f) Confirmation and sign off routine (545) - send the order confirmation, if any, to the subscriber terminal. This includes the receiver authorization code to
25 allow receipt of the transmission when it occurs and codes to determine how long or how many times the video program segment may be viewed before it is automatically erased. A confirmation message is displayed to the customer (550). Send the authorization codes (555). Preferably, each
30

1 customer is assigned a unique identification number and at
the beginning of each program segment, the ID is transmitted
in a data block along with the authorization code and/or
decryption code. This technique provides the flexibility to
5 change the mix of customers to receive a particular
transmission up to the time the program is actually
transmitted.

g) Send sign off message to subscriber
terminal and hang up the phone (560).

10 h) Order processing complete. Delete the
NewOrder data object and go to step 400 to wait for a new
incoming call.

Scheduling

15 The Scheduling module has two primary
functions: (1) Feasibility - to quickly determine whether
it is possible to satisfy a customer's request for a
particular video segment at a certain variable time allowance
interval so that a pending order can be accepted or rejected.
20 This function is invoked from the Order Processing module
whenever a new order or a change to an order is received; and
(2) Optimization - uses a rule based approach to select the
next program segment to transmit over a channel when the
channel becomes free. The technique optimizes the delivery
25 of video segments that have been ordered to efficiently
utilize the available hardware channels while meeting
variable time allowance interval requirements. This function
is invoked just before a hardware channel is to finish
transmission of a video segment so that the selection can be
30

1 made from the current list of orders. For example, orders
for the same program segment having overlapping time
allowance intervals can be accumulated and accessed at the
appropriate delivery time so that the delivery to the
5 requested subscribers can be substantially simultaneous or
broadcasted.

For continually processing new orders without
interrupting the optimal schedule, each function maintains a
separate schedule for its own use as described under Schedule
10 Database section.

The variable time allowance interval may
include a minimum delivery time which determines the earliest
time that the program segment is to be available for viewing.
This is accomplished through the authorization codes, which
15 tell the subscriber terminal when viewing is permitted. The
actual transmission may occur early; however, such early
transmission should only be allowed when a subscriber
indicates that he has sufficient memory to receive the
program. If desired, the customer could be made aware that
20 the program segment is available before the minimum waiting
period and that an order could be processed to authorize
immediate viewing.

When the Feasibility function is invoked, it
receives the following information from the Order Processing
25 module:

- Keys into the Orders and Catalog databases
- Program length
- variable time allowance interval requested

30

-20-

35

1 If the system is split geographically with a
separate link(s) for each area, the link that serves each
customer must be identified in the Customer database, and the
schedule must contain two parts: the schedules for the
5 communication lines and the schedules for the transmission
control channels. If the fiber optic link is not
geographically split, all subscriber terminals may receive
the same transmissions, and the number of control channels
should equal the number of program segments that can be
10 multiplexed on the fiber link at any one time.
Alternatively, with high speed dial-up transmission
capability, each transmission control unit can be connected
directly to any number of subscriber terminals, and any
number of control units may be used (limited only by the
15 number of different program segments in the library). In
either of these cases only the control channels need to be
scheduled.

 Figures 6 and 7 are program flow diagrams of
the Feasibility Scheduling process, generally as follows:

20 Determine the latest time that delivery can be
completed for the requested variable time allowance interval;

 Search existing Feasible Schedule for the
requested video segment (605);

 If the video segment is found (610) and if the
25 scheduled time satisfies the requested variable time
allowance interval (645) (assuming proper link schedule on a
geographically split system), then return a code to Order
Processing that the order can be accepted (675). Otherwise

30

35

1 copy the current Feasible Schedule into a tentative working
schedule (615);

If the video segment is found (610) but the
scheduling time does not satisfy the requested variable time
5 allowance interval (645), remove the program segment from the
schedule (650, 655). For a geographically split system,
remove the program segment from the tentative schedule for
the appropriate geographic link;

10 Insert the program segment into the schedule
at the latest possible time. Maintain the latest time order
by inserting at the proper location and shifting other
segments forward if necessary and if possible. When trying
to insert the program segment into the schedule, check for
conflict with other program segments for the same customer at
15 the same time, and, if there is a conflict, insert at the
latest possible time when there is no conflict (620);

If the insertion was successful (625), save
the tentative schedule as the new Feasible Schedule (660) and
return a code that the order can be accepted (680);

20 Otherwise if there is no lower variable time
allowance interval (630), delete the tentative schedule (665)
and return a code that the offer must be rejected (685);

If a lower variable time allowance interval
exists, lower the variable time allowance interval, and try
25 to insert the segment into the schedule (635);

If successful, save the tentative schedule as
the new Feasible Schedule (640, 670) and return (690),
indicating the highest variable time allowance interval than
can be scheduled. Otherwise, go back to step 630.

30

-22-

35

1 For a geographically split fiber link system,
the insert program segment routine (steps 620, 635) is
expanded as shown in Figure 7, to first schedule (705, 710)
the link and then the channel (715 to 730) so that
5 coordination between different links can be effected.

Figure 8 is the flow process when the Feasibility function is invoked by the OrderProcessing module to delete an order from the Feasible Schedule. The process include:

10 Search the Orders database for other orders of
this same video segment (805).

 If no other order exists (810), then remove
the video segment from the Feasible Schedule (815, 820).

 If the order exists, get the latest delivery
15 time for the new segment and move segment later in the
schedule if possible (825, 830).

 Return to the calling program (835).

 The Optimization function is invoked (via a
timer scheduled by the Transmit module) just before a
20 hardware channel completes delivery of its video segment.
Sufficient time is allowed so that the optimization can be
completed. The function may also be invoked if the Transmit
module finds that the schedule needs to be reoptimized before
initiating the transmission of a video segment. This
25 function selects only the next video segment to be
transmitted for each hardware channel. It is not practical
to try to optimize the complete schedule since new orders
would require it to be continually reoptimized.

30

35

1 Referring to Figure 9, the first step in the
processing is to calculate the slack time for each program
segment in the Feasible Schedule (905). The slack time is
the time remaining before a program segment must be started
5 to just meet its required delivery. It can be obtained
directly from the Feasible Schedule; however, if there were a
conflict in scheduling two or more program segments at the
same time for any customer, then the minimum slack time over
all of the conflicting programs is used as the slack time for
10 each of those programs. Next retrieve estimates of the rates
at which orders are expected to be placed for each program
segment at this day and time, including estimates for express
deliveries. These rate estimates can be computed off-line
based on recent statistics. The selection of the segment to
15 schedule for next transmission is based on the following
factors: (1) Slack time for each program segment to be
scheduled; (2) Estimated rate of arrival of orders for each
program segment to be scheduled; (3) Estimated rate of
arrival of orders for new program segments; (4) Estimated
20 rate of arrival of express orders for new program
segments: (5) How much free time is there in the Feasible
Schedule; (6) Current channel status, including when each
will become free; and (7) If any of the customers receiving a
transmission have other program segments on order and, if so,
25 when their current transmission is scheduled to be complete.
The selection of which segment is to be transmitted next on a
particular open channel is made by applying a set of rules to
compute a weight for each segment. This weight ranges from 0
to 1, and the segment with the highest weight is selected for
30

1 transmission (930). A weight is also computed for the
channel to remain idle for a specified time period. The
rules for computing the weights are listed below. Weights
from the different rules are combined in the manner used to
5 combine certainty factors as described in Rule Based Expert
Systems: The MYCIN Experiments of the Stanford Heuristic
Programming Project, B.G. Buchanan and E.H. Shortliffe, Eds.,
Addison-wesley, Reading, MA, 1984, pp. 272-280. The
descriptions in these pages are incorporated by reference
10 herein.

1. For each segment find how many channels
will complete their current transmission within the slack
time. Set the weight for that segment to the reciprocal of
that number (910). If the number is one for any segment
15 (915), select that segment immediately and return (920, 955).
If there is more than one such segment, choose the one that
is to be transmitted to the most customers.

2. For each segment, add a small amount of
weight inversely proportional to the estimated arrival rate
20 of orders (925). For the idle channel weight use the rate of
arrival of new program orders.

3. Add a small amount of weight to each
segment, proportional to the expected arrival rate of new
orders up to a preset limit (925). This is to encourage the
25 transmission of existing orders so that channels will be free
later to handle new orders.

4. Combine a small amount of negative weight
proportional to estimated arrival rate of new express orders
up to a preset limit. Add proportional weight to the idle
30

1 channel weight. The basis for the weight in this case is
moderate if there is a large amount of free time in the
Feasible Schedule; otherwise, it is small. The large or
small decision can be made by applying fuzzy logic. This
5 rule is to encourage leaving some channels free to handle
express orders. The program segment with the highest weight
is selected (930) and checked against the list of program
segments currently being transmitted (935). If there is a
conflict, the program segment with the next highest weight is
10 selected (940).

If a channel is to remain idle by the
application of these rules (945), a timer is set to poll that
channel again in about 10 or 15 minutes (945, 950). The
amount of weight to be added in applying these rules (small,
15 moderate, etc.) is for a small weight to be preferably around
0.1 and a moderate weight to be around 0.3. The weights
could be updated as operating experience has gained. For
example, if the rate of arrival of express orders is less
than what has been experienced, the idle channel weight would
20 be reduced.

For the geographically split system, the rules
should be applied to the Feasible Schedules for both the
channels and the links. An additional rule for coordinating
more than one link with a channel would be that once a
25 segment is selected for transmission on a particular link,
see if it is also needed on other links. If so, then wait
for those links to become available if the wait is not too
long and if it doesn't violate the slack time for other
segments on the new link.

30

-26-

35

1 Transmit

The Transmit module controls the actual transmission of the video program segment. It uses the Optimal Schedule to determine which segment to transmit over a particular hardware channel (steps 1000 to 1045). Keys obtained from the Optimal Schedule (1015) point into the Orders and Catalogue databases, which in turn contain keys into Customer and Library. When transmission of the program segment is complete, the corresponding entries in the Optimal and Feasible Schedules (1050) are deleted and all appropriate Customer records are updated to indicate that delivery has been made (1020, 1035). When transmission of a new video segment is initiated, a timer is set to start up the Optimization Scheduling function (1060) just before delivery is scheduled to complete.

Library Maintenance

This module (not shown) is used to add or remove available program segments to or from the Library and update the corresponding entry in the Catalog. It is initiated by operator selection from the main system menu.

Customer Maintenance/Billing

This module (not shown) is initiated by operator selection from the main system menu. There are two main functional areas that are involved:

- 25 - Update of all user information including that need to authenticate customer identity.
- Generate customer bills from the record of program segment deliveries in the Customer database.

30

-27-

35

1 Implementation of this module is readily apparent to an
ordinarily skilled programmer.

SUBSCRIBER TERMINAL SOFTWARE

5 Through the PC keyboard and monitor at the
subscriber terminal, order entry and program viewing are
controlled using a menu selection approach in which a set of
options are displayed on the monitor and the customer enters
his choice via the keypad. This technique is similar to that
10 currently used for programming a VCR. The keypad need only
have a set of numeric keys (0-9) and an ENTER key. If
desired a BACKSPACE key could be added to allow for
correction of a miskey before ENTERing the selection.

When the customer wishes to make a request,
for example to place or modify an order or to view a program
15 segment which he has already received, he presses the ENTER
key. The system responds by displaying a menu on the video
screen and waits for the customer to enter a response through
the keypad by pressing the numeric keys that correspond to
the desired menu selection and then pressing ENTER. If a
20 program segment was being viewed on the monitor when the
ENTER key was pressed, that program pauses until the customer
is finished with the menu selections. On return from the
menus, the customer has the option to resume viewing the
program, to stop viewing, or to select a different program.

25 The Subscriber Terminal subsystem is driven by
two types of events which generate hardware interrupts: 1) a
key being pressed on the keypad and 2) the communications
hardware recognizing the start of a video program segment
being transmitted over the communication line. Keypad events

30

-28-

35

1 are handled by the Request module or by a standard keyboard
processing routine, depending on the state of the system.
The communications event invokes the Receive module, which is
responsible for getting the incoming program segment off the
5 communication line and storing it to disk. The Receive
module can run in the background in a multi-tasking mode
while other processes such as order entry, program viewing,
or making a permanent copy are in progress.

The Subscriber Terminal software system
10 consists of seven modules, some of which are subroutines
called from the other modules.

Referring to Figure 11, the Start up- module,
which is run when the system is first powered up (1100),
retrieves receive authorization codes (1105) and initializes
15 the communications hardware (1110) and then sets up the
interrupt processors for the keypad and the communications
hardware (steps 1115, 1120).

The receive module is invoked by an interrupt
from the communications hardware on the start of transmission
20 of a new program segment (1130). The module first checks
whether this Subscriber Terminal has been authorized (1135,
1140) (through the Process Order module) to receive the
program segment. If so, the module grabs the incoming blocks
of program data from the communication line and stores them
25 to disk (steps 1145, 1155 and 1160). The module continues to
run in the background (at high priority) in a multi-tasking
mode until all blocks of the program segment have been
received. Alternatively, the authorization code may be
transmitted to the subscriber terminal as described in the

30

35

1 Distribution Center Order Processing module. In that case,
the Receive module examines the list of customers in the
first block of a program segment to see if it is authorized
to receive that program. If so, the authorization code that
5 is sent with that block is extracted to identify which of the
subsequent blocks belong to that program segment.

Referring to Figure 12, the request module,
which handles all customer requests which are entered through
the key pad (steps 1205, 1210, 1215). First, if a program
10 segment is being viewed, it notifies the View module to pause
(1220, 1225). It then displays some basic menus to ask the
customer whether he wants to process an order or to view or
stop viewing a program segment (steps 1230, 1235, 1240,
1245). Depending on the response, it calls the ProcessOrders
15 (1295) or the SelectView subroutines (1265), each of which
presents more menu selections. A more complete description
of this module is given below.

The ProcessOrders routine is shown in Figures
13 and 14. This subroutine is called by the Request module
20 or by the SelectView subroutine to interactively communicate
with the distribution center. Subscriber orders or requests
for extension of viewing time or number can be made through
this routine. The subscriber dials up the Distribution
Center and interfaces with the Order Processing module
25 (1305). The menus that are displayed by this module are
preferably at the Distribution Center and passed as messages
over the low speed communication link 130. Upon receipt and
verification of the subscriber or customer ID information
(1325, 1335), the distribution center sends a menu packet to

30

-30-

35

1 the subscriber (1340). These menus include lists of
available programs, programs currently ordered but not yet
delivered, pricing information, etc. The customer enters his
response from the keypad and transmits that response back to
5 the Distribution Center (1355). If an order is placed or an
existing order is changed, the authorization codes are sent
to the Subscriber Terminal. A more complete description of
the module is given below.

The SelectView module is shown in Figure 15.

10 This subroutine is called by the Request module to allow the
customer to select for viewing any one of the programs
segments that are available on the hard drive or the WORM
drive at the subscriber terminal. If the selected program
segment has expired (either date/time or number of plays), it
15 asks the customer whether the order should be extended. If
so, it calls the ProcessOrders subroutine so that
authorization can be obtained from the Distribution Center.
Otherwise, it asks if the program segment is to be deleted to
free up disk space. Note that an expired program is not
20 immediately deleted even though it cannot be viewed. This
allows the customer to extend his authorization without the
necessity of retransmitting the program segment. As an
alternative implementation, the list of available programs
could include those that have been received but not yet
25 authorized for viewing because of the minimum wait time for
the selected variable time allowance interval. The customer
could be prompted to process an order to receive
authorization for immediate viewing.

30

-31-

35

1 The View module is shown in Figure 16. This
module controls the actual viewing of a program segment. It
is initiated by the Request module after a selection has been
made using the SelectView subroutine. It may run at the same
5 time as the Receive module in a multi-tasking mode. A flag
or semaphore set by the Request module is used to tell the
View module when to pause in viewing a program. When a pause
flag is detected, the current program state is saved so that
viewing may be resumed later if desired. A parameter passed
10 to the view module identifies whether to resume a program, to
terminate a program, or to start a program from the
beginning.

The Copy module copies a program segment from
the hard disk to a removable storage medium such as a WORM
15 disk. It executes in the background in multi-tasking mode at
a very low priority.

Request module

This module is one of two modules that process
hardware interrupts from the keypad. When the system is
20 powered up, the start up module directs that any keypad
interrupts be processed by the Request module. All keys but
the ENTER key are ignored at this point, causing the module
returns immediately. When the ENTER key is pressed, however,
the module becomes ready to handle a customer request. It
25 first directs that keypad interrupts be processed by a
standard keyboard interrupt processor, which places key
presses in a queue where they may be accessed by standard
input functions. Next, it checks whether a program segment
is currently being viewed, and, if so, it sets the flag in
30

- 1 the View module to tell that module to pause. It then
displays a menu on the monitor and waits for a response to be
entered via the keypad (using standard input routines). The
menu options and subsequent actions are as follows:
- 5 1. Stop viewing (1240) (only if a program
segment was being viewed)
 invoke the View module to terminate the
 current segment (1255). The program then
 is no longer in the pause state.
- 10 2. Resume viewing (1250) (only if a program
segment is currently in the pause state)
 a) direct the keyboard interrupt processing
 to invoke this Request module (1280).
 b) invoke the View module with "resume"
15 parameter (1282)
 c) return (1283)
3. Process a new order (1285) (may be
 selected at any time)
 a) call the ProcessOrder subroutine with
20 "new order parameter" (1295)
 b) go back to display a new menu on the
 video screen (1230)
4. View a new program segment (1245) (only
if no program is currently in the pause state)
- 25 a) call the SelectView subroutine (1265)
 b) direct the keyboard interrupt processing
 to invoke this Request module (1280)
 c) invoke the View module with "begin view"
30 parameter (1282)

- 1 d) return (1283)
5. Permanent copy - customer has previously purchased authorization to copy a program segment to a removable storage medium such as a WORM disk (1201, 1202).
- 5 a) prompt customer to insert disk, wait for response (1203)
- b) invoke the Copy module to copy the program segment to the removable medium in a multi-tasking mode at very low priority; continue execution of this module
- 10 c) go back to display a new menu on the video screen (1230)
6. Quit (only if no program is currently in
- 15 the pause state)
- a) direct the keyboard interrupt processing to invoke this Request module (1280)
- b) return (1283)

Notice that before returning from this module, the keypad
20 interrupt processor is set for this Request module.

Process orders subroutine

This subroutine may be called from the Request module or the SelectView subroutine. A parameter is passed to indicate where it is called from. The first step is to
25 dial up the Distribution Center (1305) and establish communication with the Order Processing module there. It sends the customer identification information (1325), including any passwords if desired, and tells whether to
process a new order (where this subroutine was called by the
30

1 Request module) or an extension to an existing order (where
this subroutine was called by SelectView). After receiving a
validation of the customer identification from the
Distribution Center, it waits for a message packet (1335,
5 1340). The message options are shown below with the
corresponding actions taken. All keypad entries are
processed using standard input routines where a number is
followed by ENTER.

1. Interactive messages (1345) - these are
10 the menus constructed by the Distribution Center to be
displayed on the video screen

- a) display the message and wait for a
response through the keypad (1350)
- b) transmit the response back to the
15 Distribution Center (1355)
- c) go back to wait for another message
packet from the Distribution Center
(1340)

2. Authorization code for a particular
20 program segment (1375)

- a) if this is for a new order, add the
authorization to the list of program
segments to be received (1390), transmit
an acknowledgement to the Distribution
25 Center (1360), and go back to wait for
another message packet
- b) if this is for an existing order that has
been placed but not received yet, modify
the authorization in the list of program

30

35

- 1 segments to be received (1395), transmit
an acknowledgement to the Distribution
Center, and go back to wait for another
message packet
- 5 c) if this is an extension to the expiration
status for a program segment already
received, modify that expiration status
(1395), transmit an acknowledgement to
the Distribution Center, and go back to
10 wait for another message packet
3. Check disk space (1400) - this code tells
the Subscriber Terminal to verify whether there is sufficient
disk space to store the requested program segment
- 15 a) If there is sufficient room (1405),
transmit an acknowledgment to the
Distribution Center, and go back to wait
for another message packet (1410)
- 20 b) Otherwise, display a menu with the
following options and wait for a response
(1415):
- i) cancel order (1420)
- transmit a cancel command to the
Distribution Center (1425)
 - go back to wait for another message
25 packet
- ii) delete file (1430)
- display a list of program segments with
their size info & expiration status
30 (1435)

- 1 - wait for response
- if a program is selected (1440), delete
 it (1445) and go back to check if there
 is sufficient room; otherwise go back to
5 (b) and redisplay the menu.

The system according to the invention is not limited to any specific means or methods of data communication between subscriber and distributor. For example, it is readily apparent to one ordinarily skilled in
10 the art that the distribution of programs can take place over CATV lines, fiber optic lines, or any other adaptable data link. Also without substantive changes, the system can be employed whether the method of distribution is a continuous
15 loop, as in conventional CATV systems, or whether the method uses dedicated or private lines, as in conventional telephone system. Regardless of the type of distribution link, the system provides interactive communication between subscriber and distributor, expanded memory for the subscriber, and a
20 flexibility for the subscriber and maximum efficiency for the distributor.

25

30

-37-

35

1 CLAIMS:

1. An interactive audiovisual distribution system comprising:

A. a distribution center having:

5 a. a library of stored audiovisual programs;

b. an order processing computer connected to a plurality of subscriber stations for handling requests for delivery of selected segments of said
10 audiovisual programs from said plurality of subscriber stations, said order processing computer being coupled to a plurality of transmission control processing units for allocating servicing of said requests to said transmission control processing unit; and

15 c. each of said transmission control processing units having:

a transmission control processor for receiving commands from said order processing computer and for handling the distribution of said requested selected
20 program segments;

a memory for storing audiovisual programs including said requested selected program segments; and
an interface for coordinating transfer of said requested program segments to subscriber stations
25 corresponding to said requests; and

B. each of said subscriber stations including:

a receiver for receiving said requested program segments from said distribution center;

30

-38-

35

1 a terminal processor having associated
memory input device and display for generating said requests
for delivery of selected segments of said audiovisual
programs from said distribution center and for coordinating
5 transfer of said program segments delivered from said
distribution center; and

a video processor for decompressing said
program segments in compressed video format.

2. A system according to claim 1 wherein
10 each of said subscriber stations further includes a memory
for storing said program segments.

3. A system according to claim 1 wherein
said order processing computer includes means for
prioritizing said requests from said subscriber stations and
15 allocate delivery of programs requested in accordance with
variable time allowance interval.

4. A system according to claim 1 wherein
said order processing computer includes means capable of
delivering requested program segments within a subscriber
20 selected minimum and maximum time period specified in said
requests.

5. A system according to claim 1 wherein
said order processing computer includes means for
interactively communicating information including program
25 segment selection and price with each of said subscribers.

6. a system according to claim 5 wherein
said means for interactively communicating includes a modem
for facilitating communication over telephone lines.

30

-39-

35

1 7. A system according to claim 1 wherein
said distribution center further includes a multiplexer for
multiplexing a plurality of said transfers of said program
segments to respective plurality of subscriber stations via a
5 single communication medium.

 8. A system according to claim 7 wherein
said communication medium is a fiber optic link.

 9. A system according to claim 1 wherein
said order processing computer further including means for
10 scheduling delivery of said requested program segments as a
function of the rate of arrival of said requests.

 10. A system according to claim 1 wherein
said order processing computer further including means for
scheduling delivery of said requested program segments as a
15 function of the availability of said transmission control
processing units.

 11. A system according to claim 1 wherein
said order processing computer further including means for
weighing each said requests and scheduling said deliveries in
20 successive weight order.

 12. A system according to claim 1 wherein
said interface between said distribution center and
subscriber station utilizes wireless transmission.

 13. A system according to claim 1 wherein
25 said interface between said distribution center and
subscriber station is digital.

 14. A system according to claim 1 wherein the
program segments stored in said memory of said transmission
control processing units is in compressed video format.

30

-40-

35

1 15. A system according to claim 1 wherein
said order processing computer further includes means for
optimizing delivery of like orders to requested subscriber
stations at substantially the same time.

5 16. A method of interactive distribution of
audiovisual programs from a distribution center to a
plurality of subscriber stations, comprising the steps of:
 storing in a library in said distribution
center a selection of audiovisual programs;
10 receiving requests from said subscriber
stations for selected program segments from said selection of
audiovisual programs, each of said requests including a time
allowance interval within which a respective selected program
segment is to be delivered;
15 processing said requests;
 accessing said selected program segments from
said library; and
 delivering said selected program segments to
respective subscriber stations making said requests within
20 respective time allowance intervals.

 17. A method according to claim 16, further
including the step of selectively varying said time allowance
intervals by said respective subscriber stations.

 18. A method according to claim 16 further
25 including the step of storing said delivered program segments
at said subscriber stations.

 19. A method according to claim 16 further
including the step of interactively communicating order
specifications including changes to said specifications.
30

1 20. A method according to claim 16 further
including the step of interactively communicating information
including program selection and price between said
distribution center and said plurality of said subscriber
5 stations.

 21. A method according to claim 20 wherein
said step of interactively communicating information includes
communicating codes to said subscriber station which
specifies the length and number of times a delivered program
10 segment may be viewed before it is automatically erased.

 22. A method according to claim 20, wherein
said step of interactively communicating codes to said
subscriber stations which specify the earliest time that the
delivered program segment is available for viewing.

15 23. A method according to claim 16 wherein
said step of processing said requests includes determining
whether to accept or reject subscriber orders based on
pending scheduled orders.

 24. A method according to claim 16 wherein
20 said step of processing said requests includes monitoring
transmission medium availability and scheduling said delivery
of program segments in order when said transmission medium is
available.

 25. A method according to claim 16 wherein
25 said step of processing said requests includes accumulating
requests having overlapping time allowance intervals for
delivering said program segments substantially simultaneously
to respective subscribers.

30

-42-

35

1 26. A method according to claim 16 wherein
said step of processing said requests includes accumulating
requests of same program segments for broadcasting said same
program segments to respective subscriber stations.

5 27. A method according to claim 16, further
including a step for optimizing delivery of said requests,
including:

(a) calculating a slack time for each
requested program segment;

10 (b) comparing the slack times of conflicting
program segments;

(c) selecting the minimum slack time among
said conflicting program segments;

(d) substituting said slack times of said
15 conflicting program segments with said minimum slack time;
and

(e) calculating the number of channels which
completes delivery of program segments within said slack
time; and

20 (f) scheduling delivery of the next program
segment based upon said slack time and channel availability.

28. A method according to claim 27, further
including the steps of:

(g) retrieving estimates of rates at which
25 orders are expected to be placed;

(h) scheduling delivery of the next program
segment based upon said minimum slack time, said estimate of
rates, and channel availability.

30

35

- 1 29. A method according to claim 16, further
including the steps for scheduling the delivery of said
requested program segments, based on request weights,
said weights are computed by:
- 5 (a) reciprocating the number of channels
which will complete their delivery within a slack time;
 (b) add a variance which is inversely
proportional to an estimated arrival rate of requests;
 (c) add a variance which is proportional to
10 an estimated arrival rate of new requests;
 (d) subtracting a variance proportional to an
estimated arrival rate of express orders; and
 (e) scheduling the requests in accordance
with delivery weight order.
- 15 30. A method according to claim 29 wherein
said variance is calculated based on fuzzy logic.
31. A method according to claim 29 wherein
said weights are updated as operating experience has gained.

20

25

30

- 44 -

35

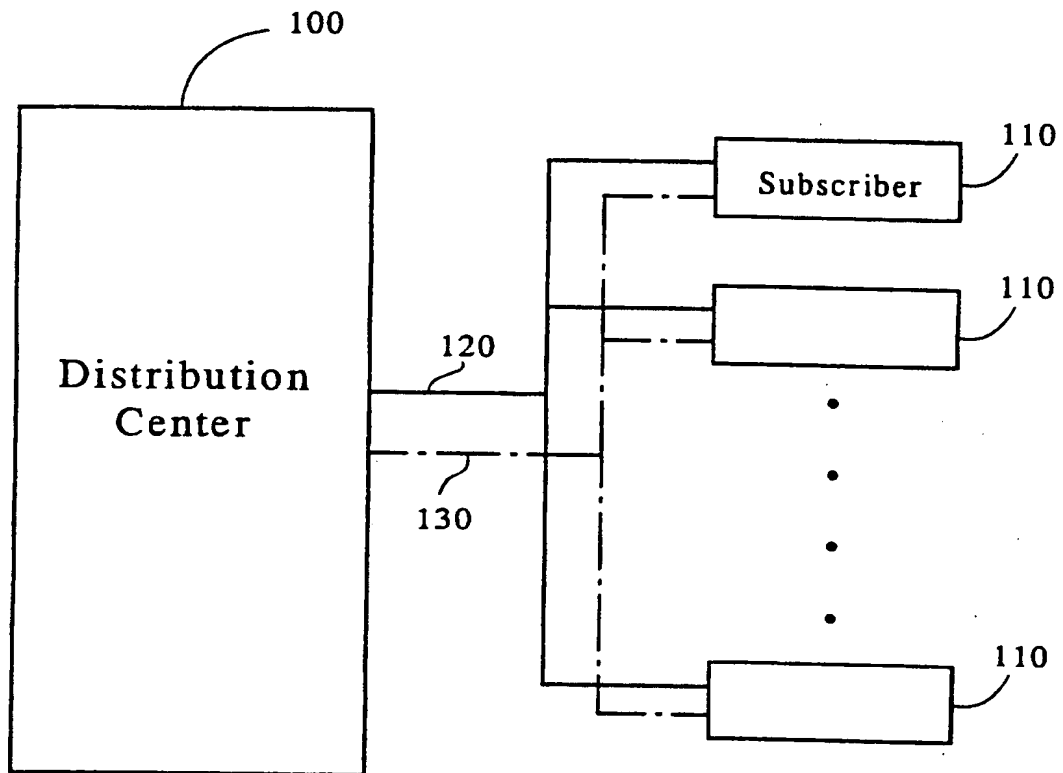

FIG. 1

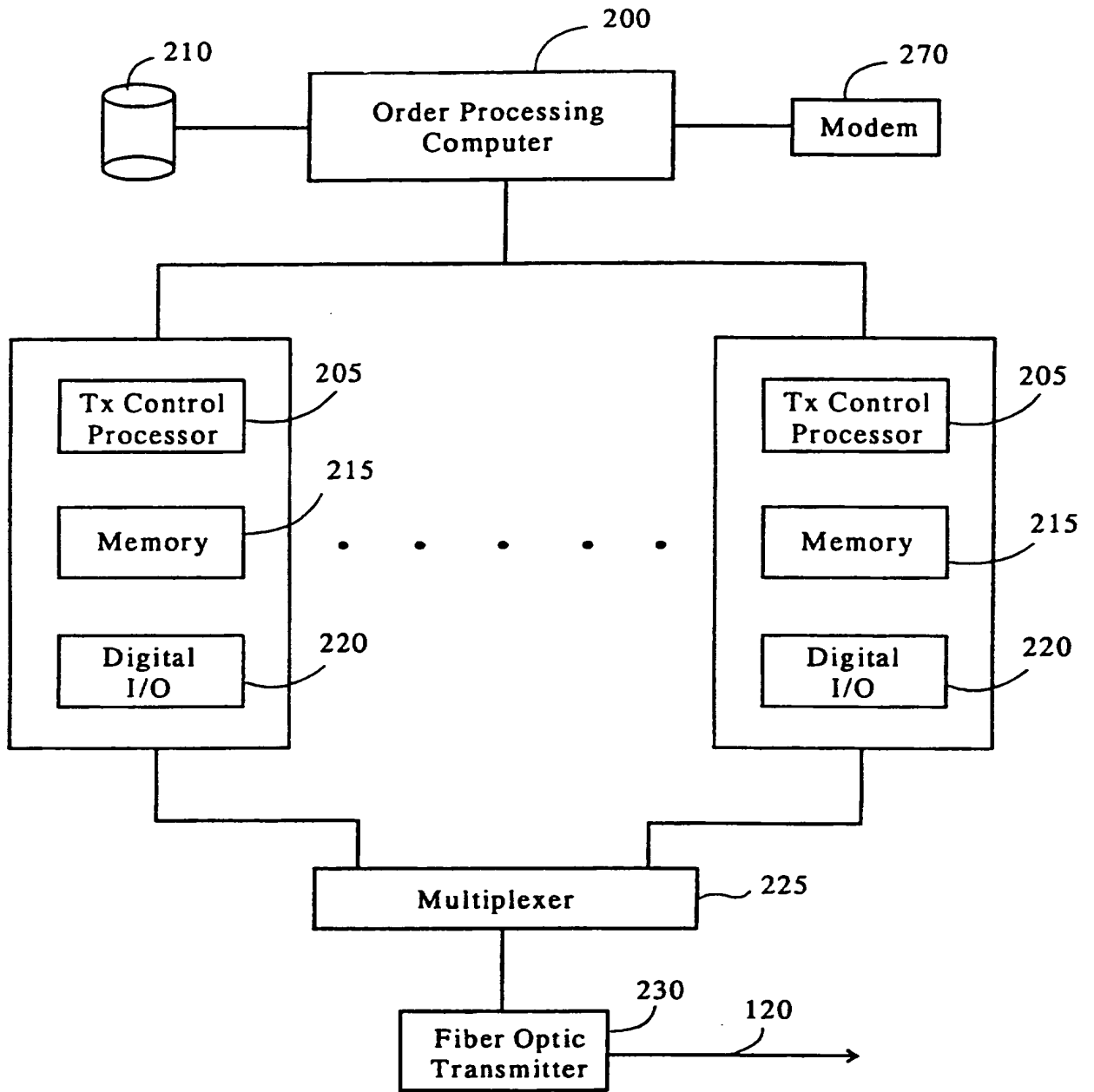

FIG. 2

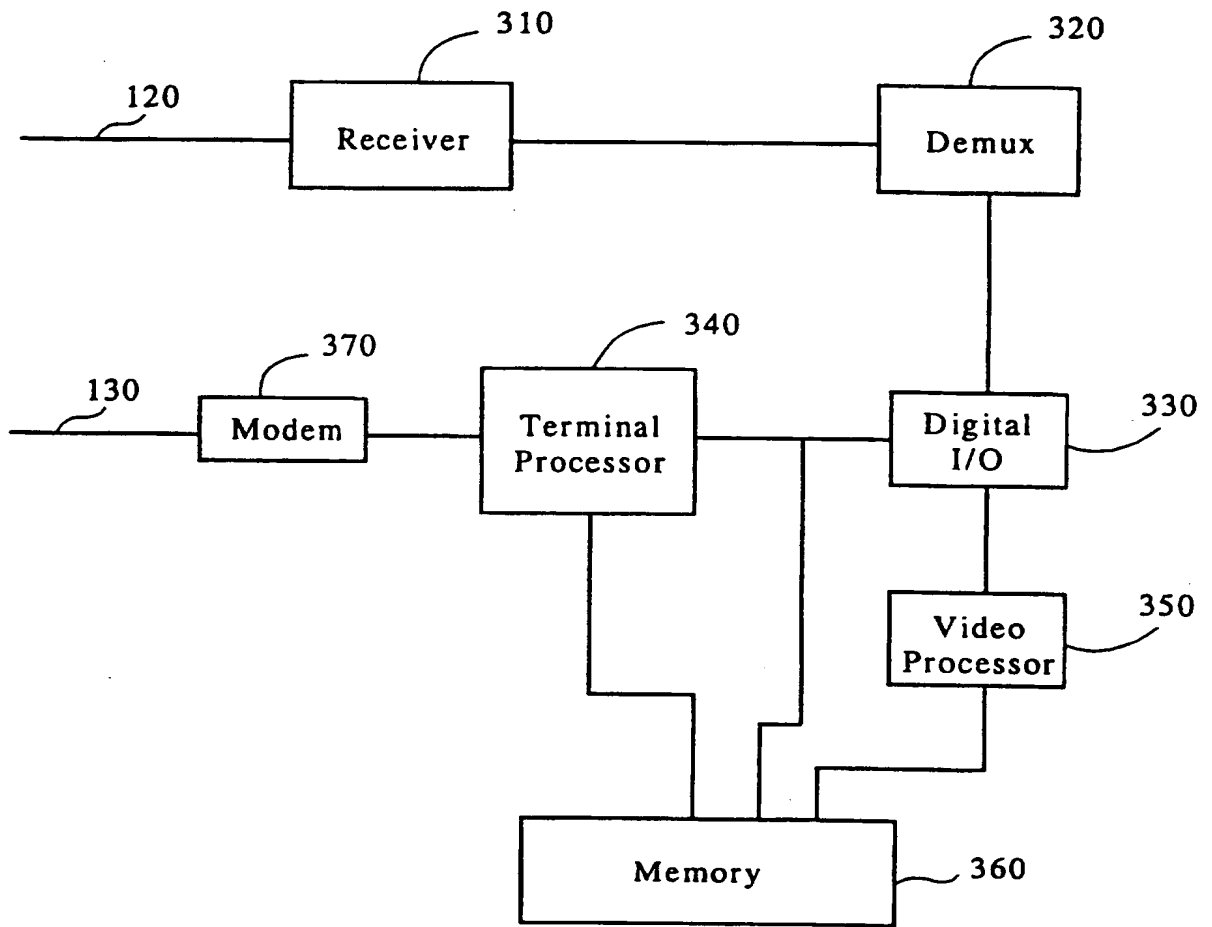

FIG. 3

ORDER PROCESSING

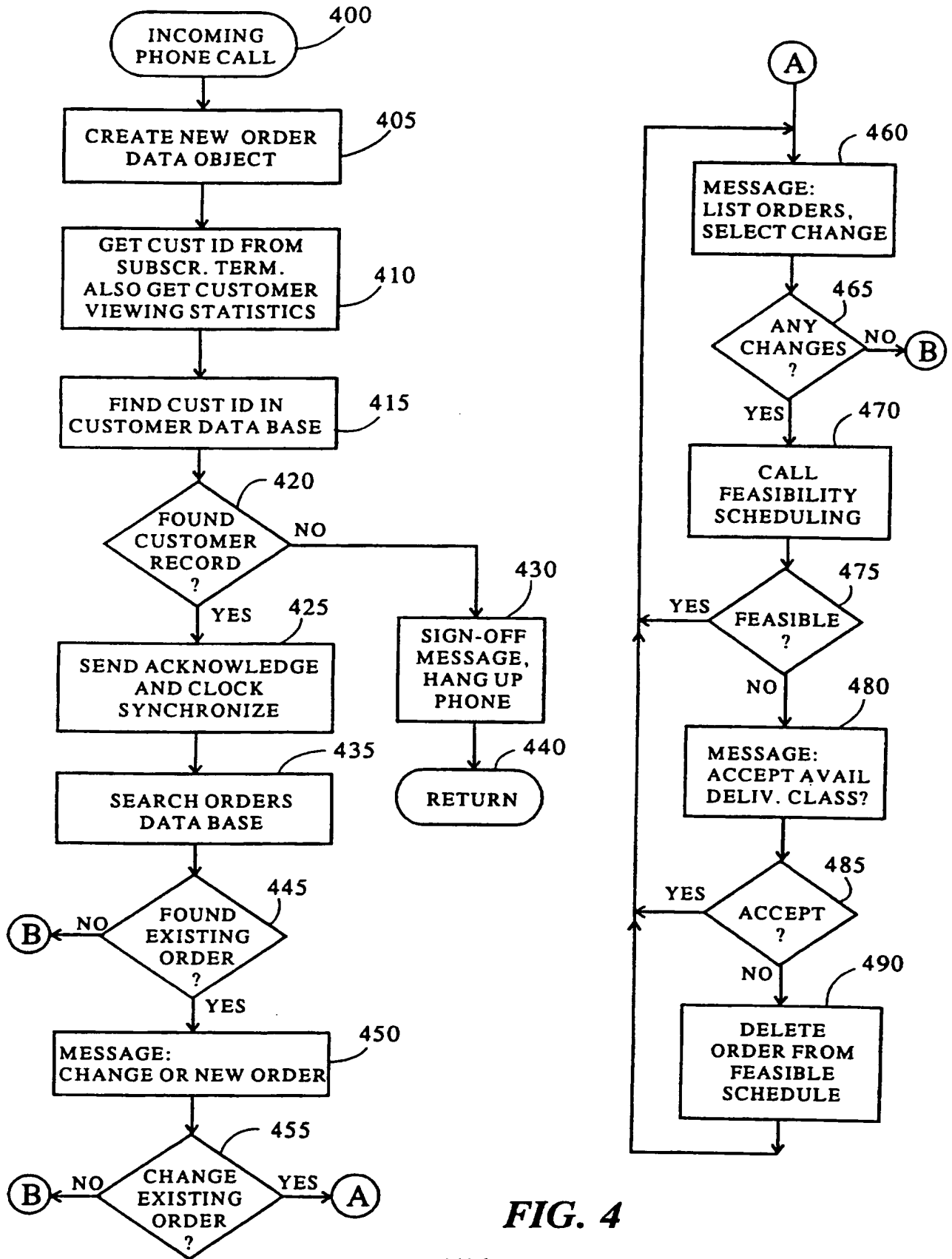

FIG. 4

ORDER PROCESSING (CONT.)

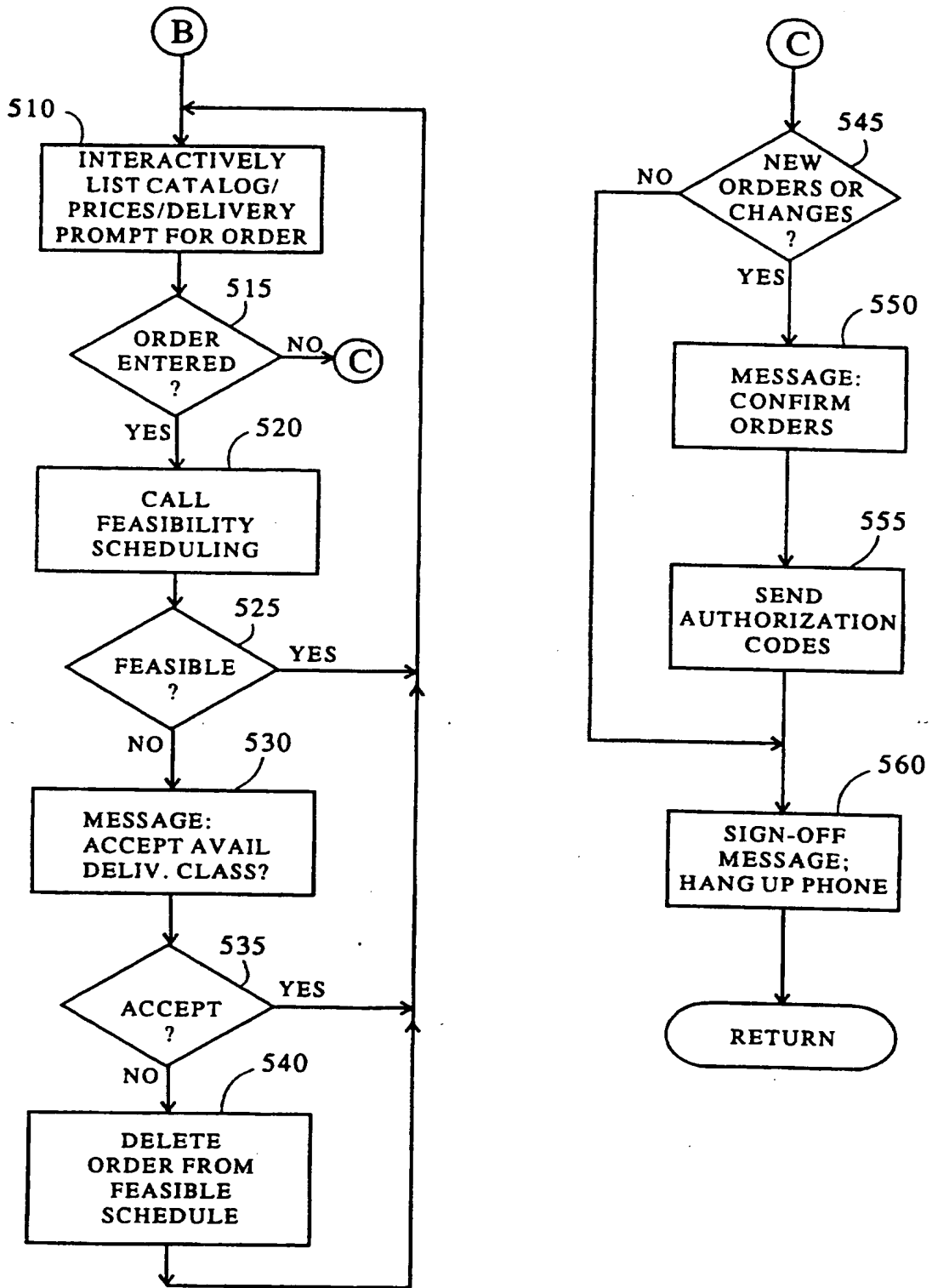

FIG. 5

FEASIBILITY SCHEDULING

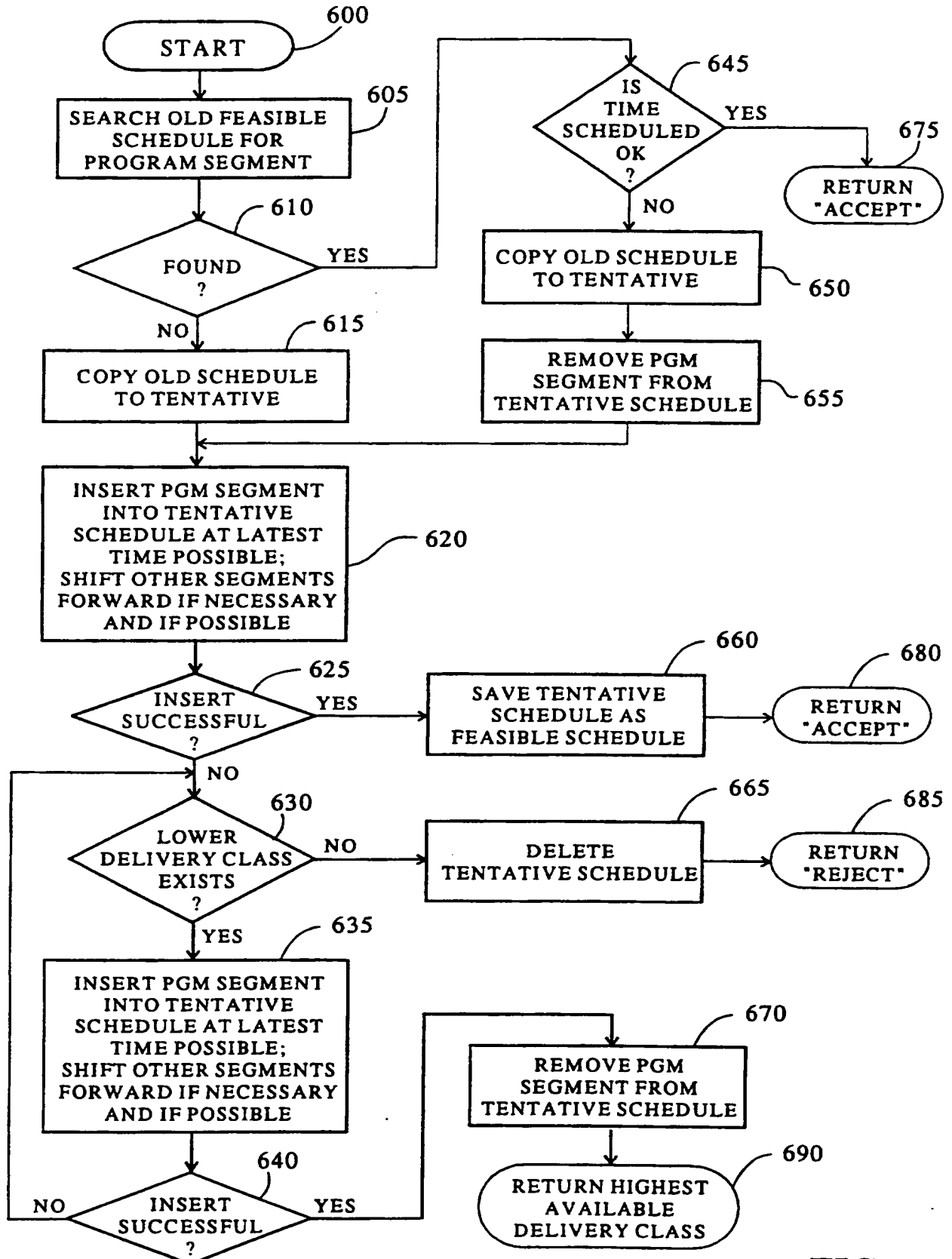

FIG. 6

FEASIBILITY SCHEDULING (CONT.)

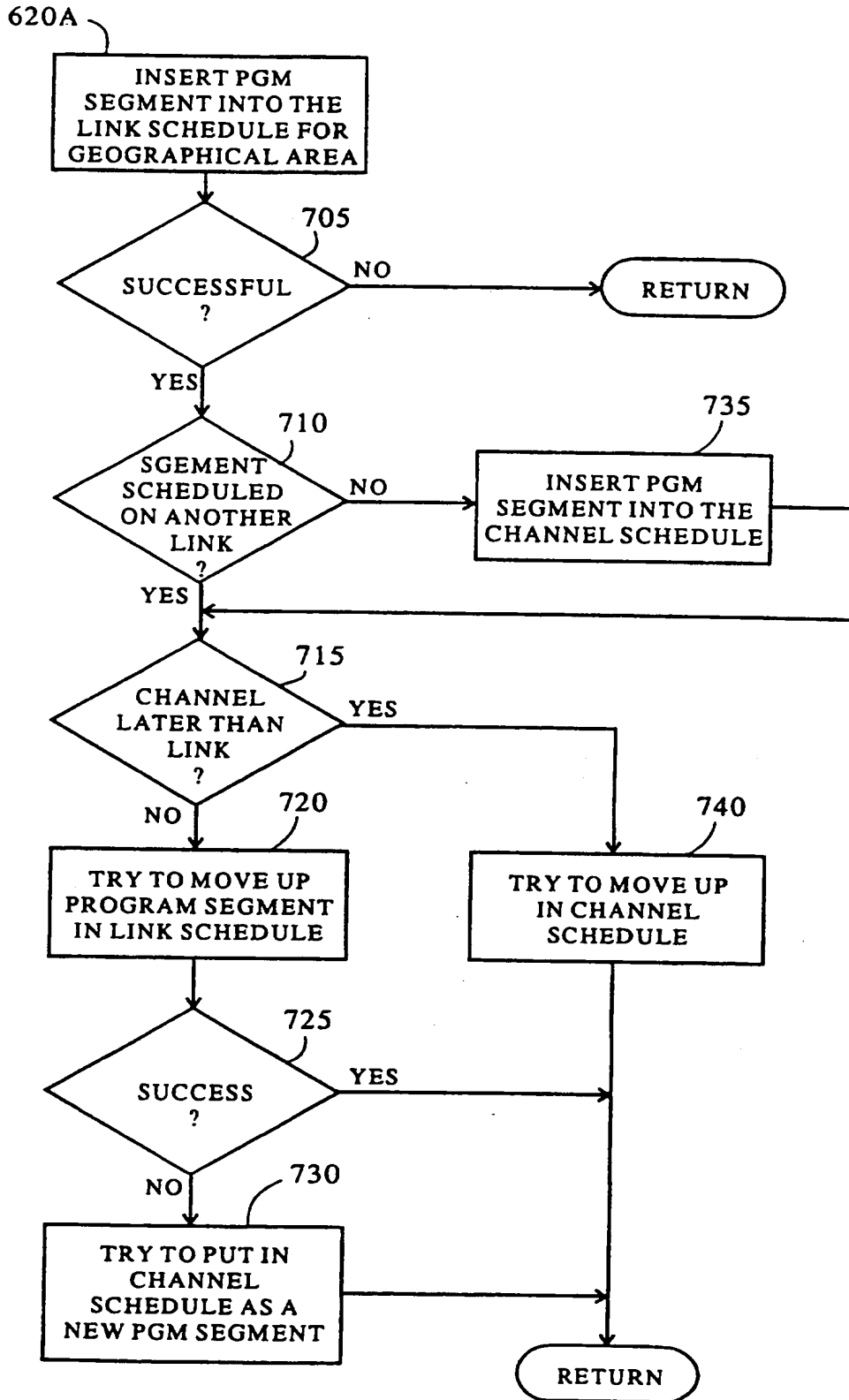

FIG. 7

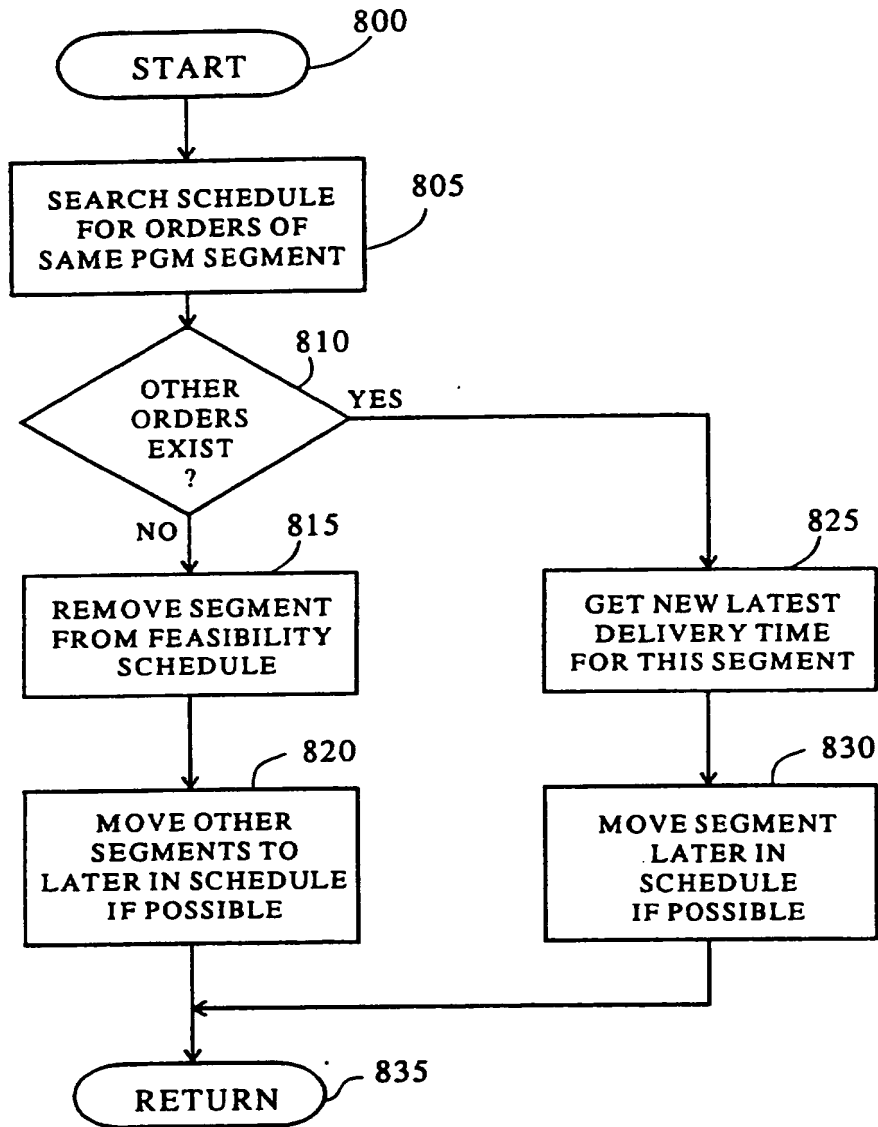

FIG. 8

OPTIMAL SCHEDULING

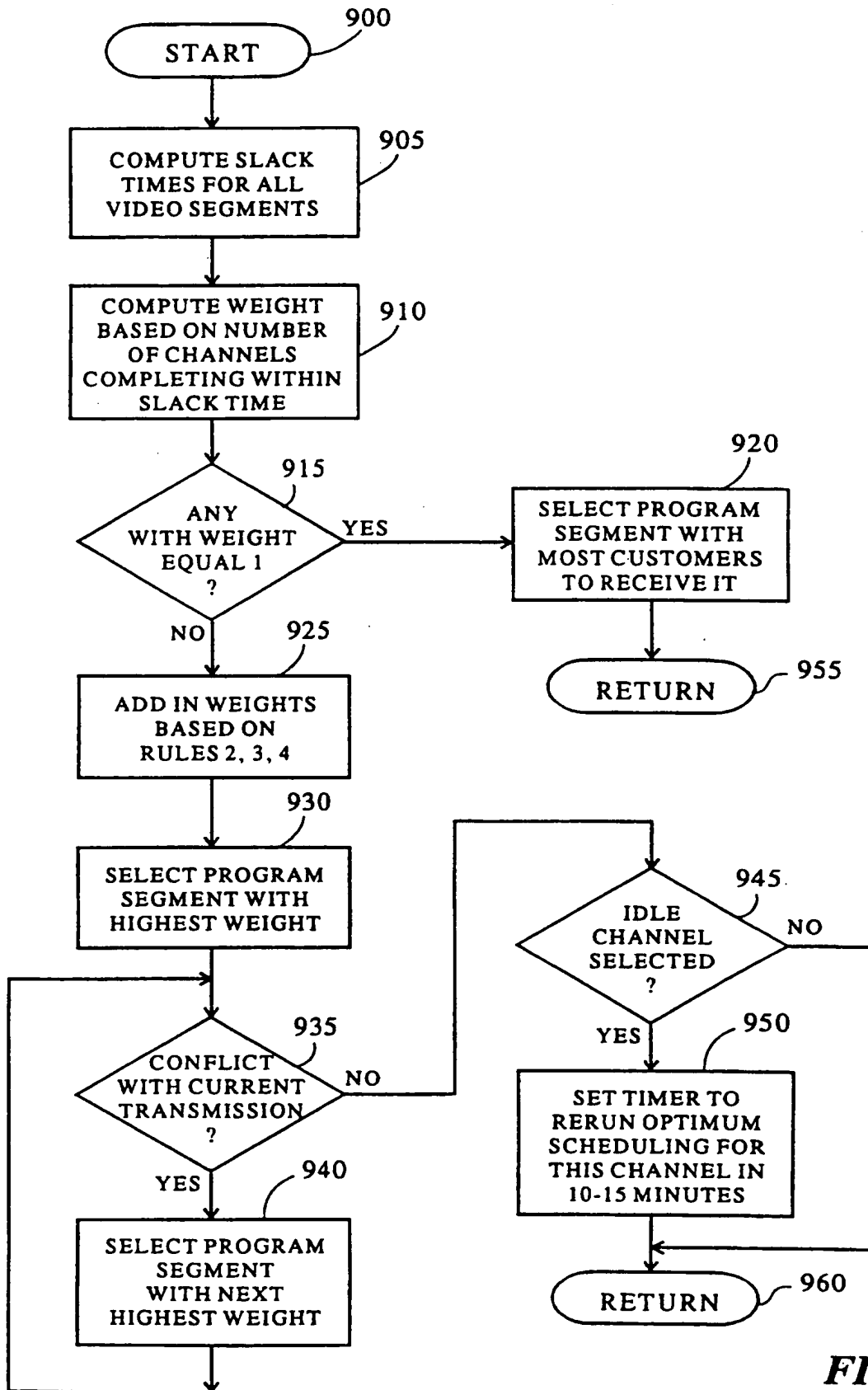

FIG. 9

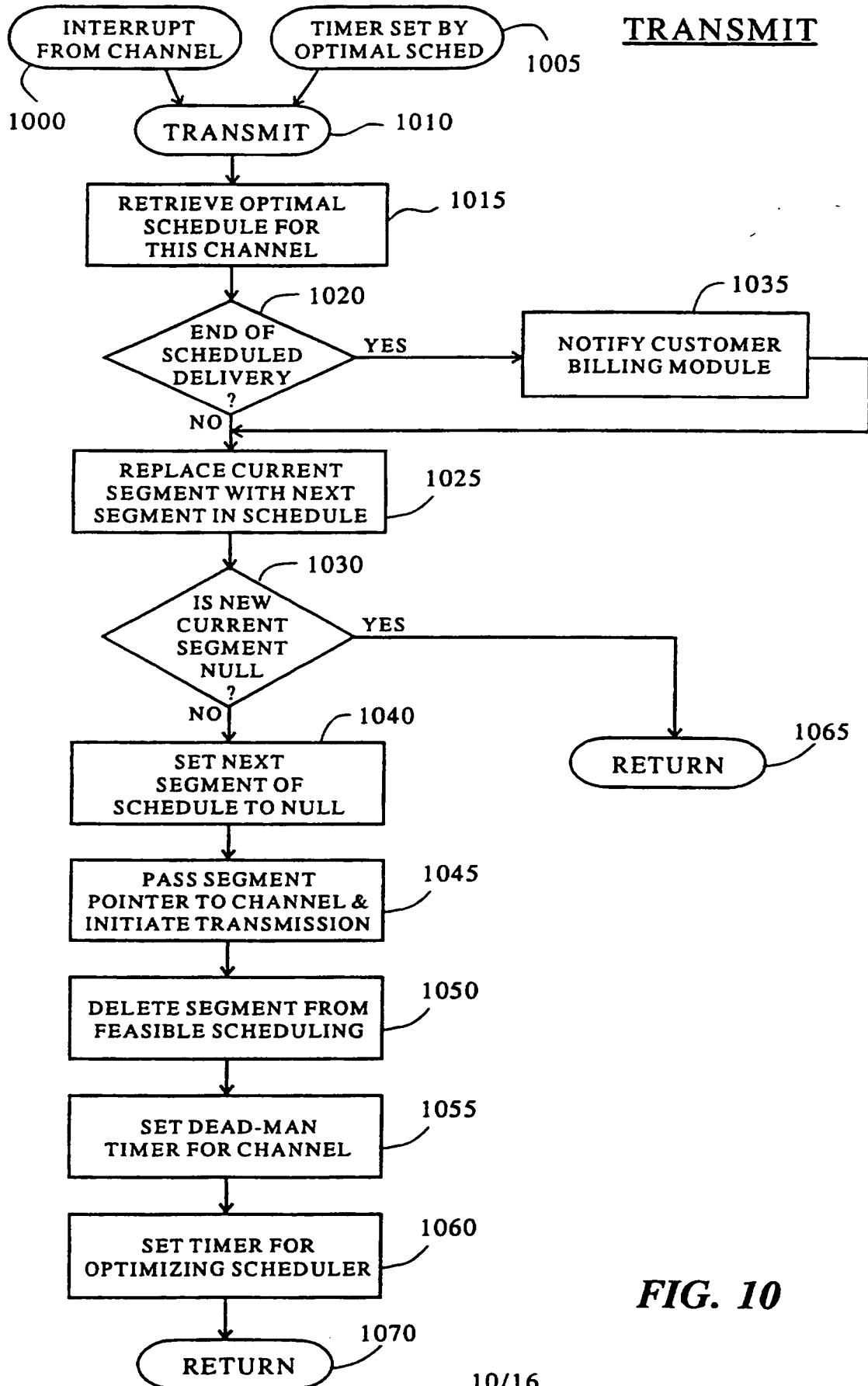
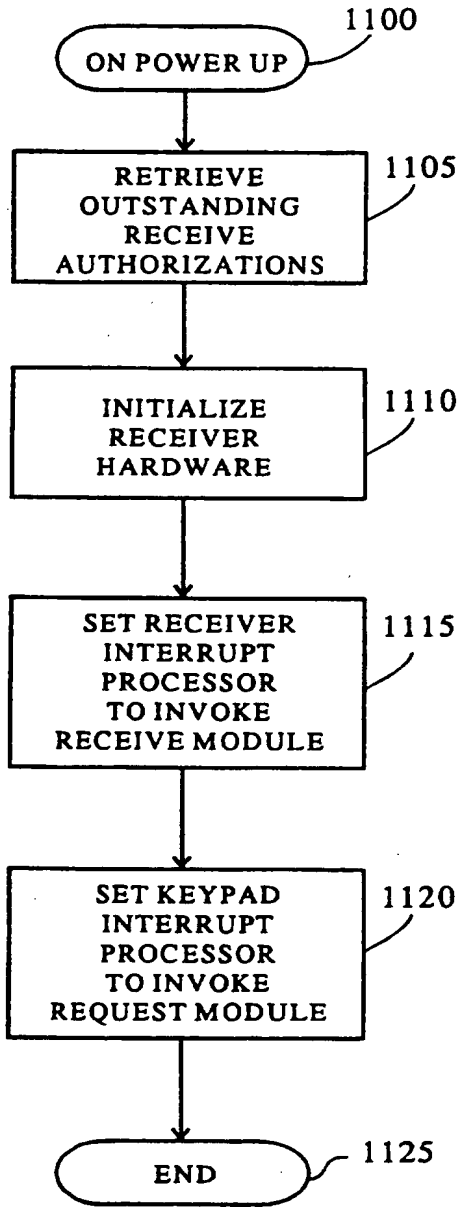

FIG. 10

START UP MODULE



RECEIVE MODULE

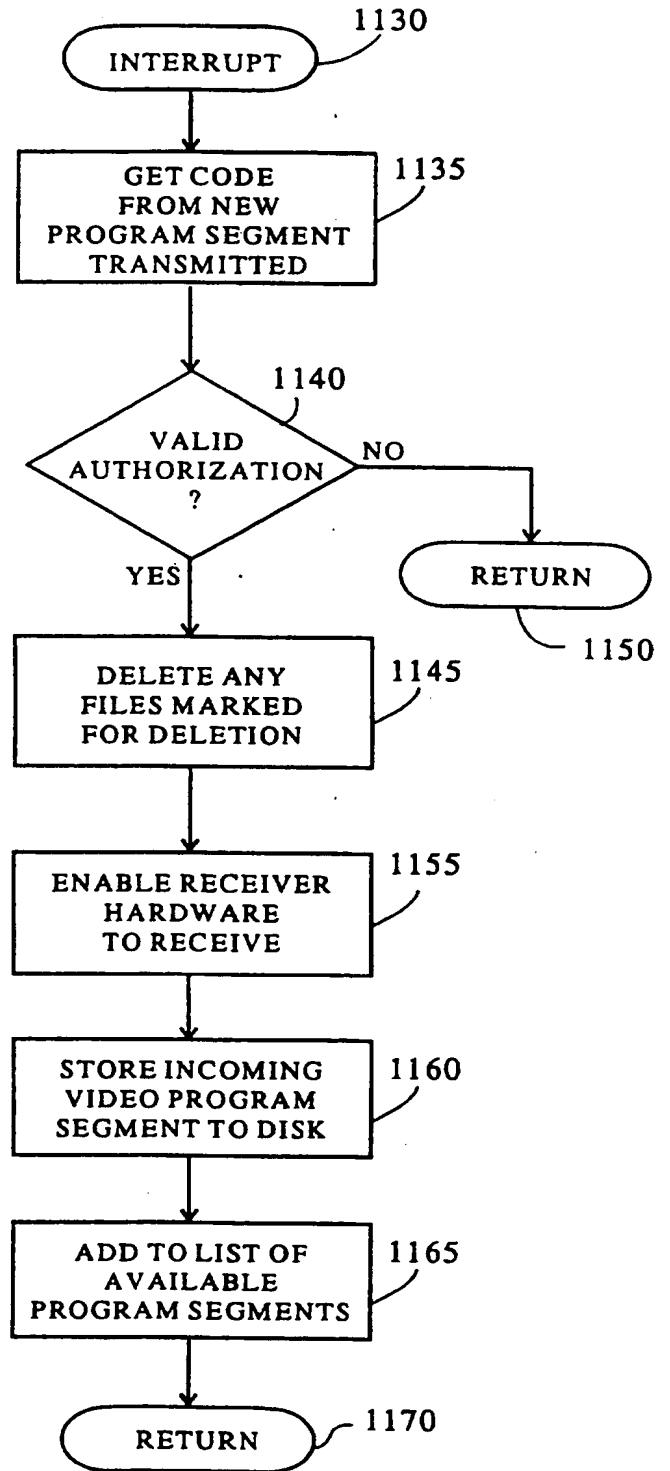

FIG. 11

REQUEST MODULE

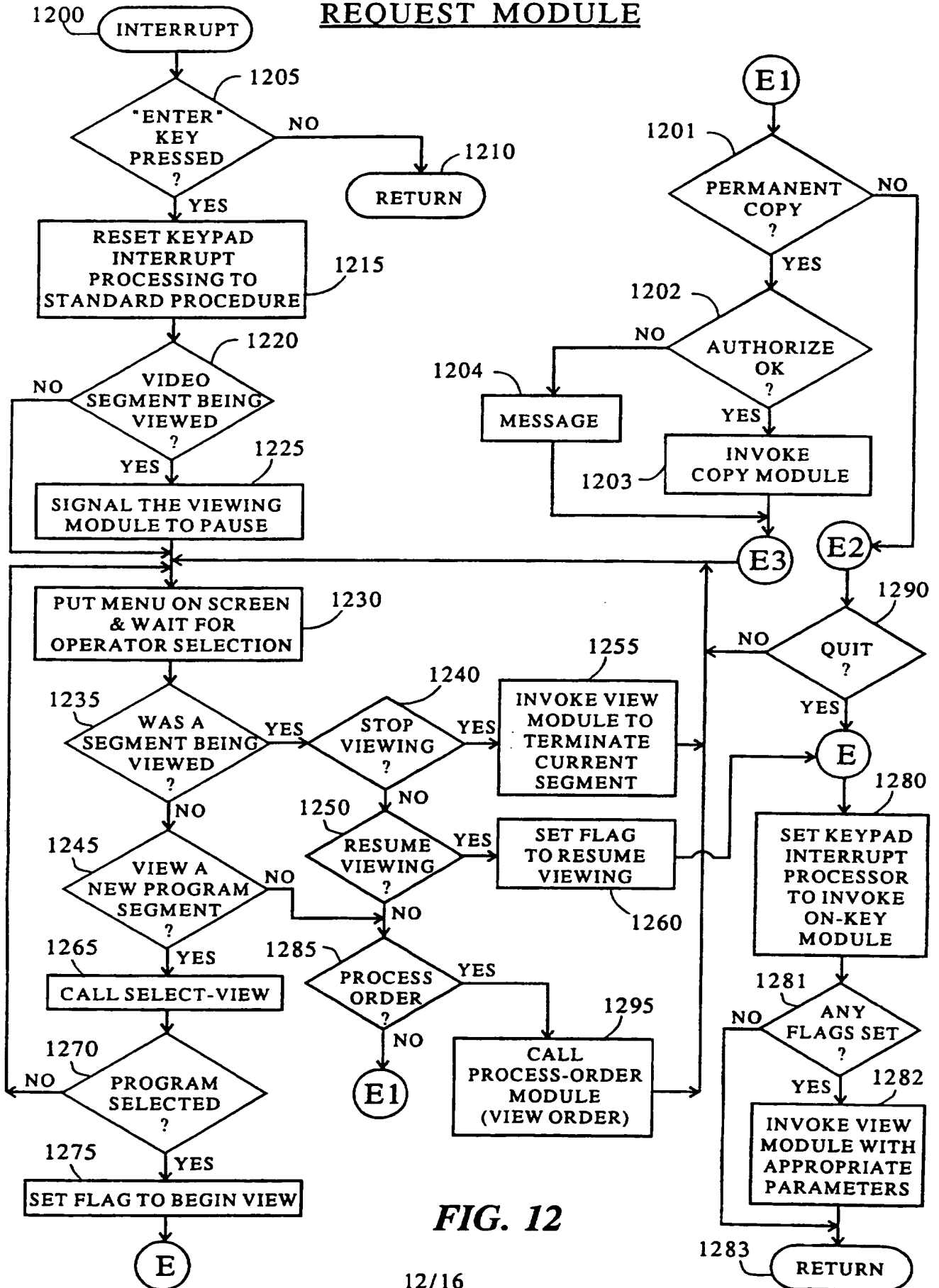

FIG. 12

PROCESS ORDERS

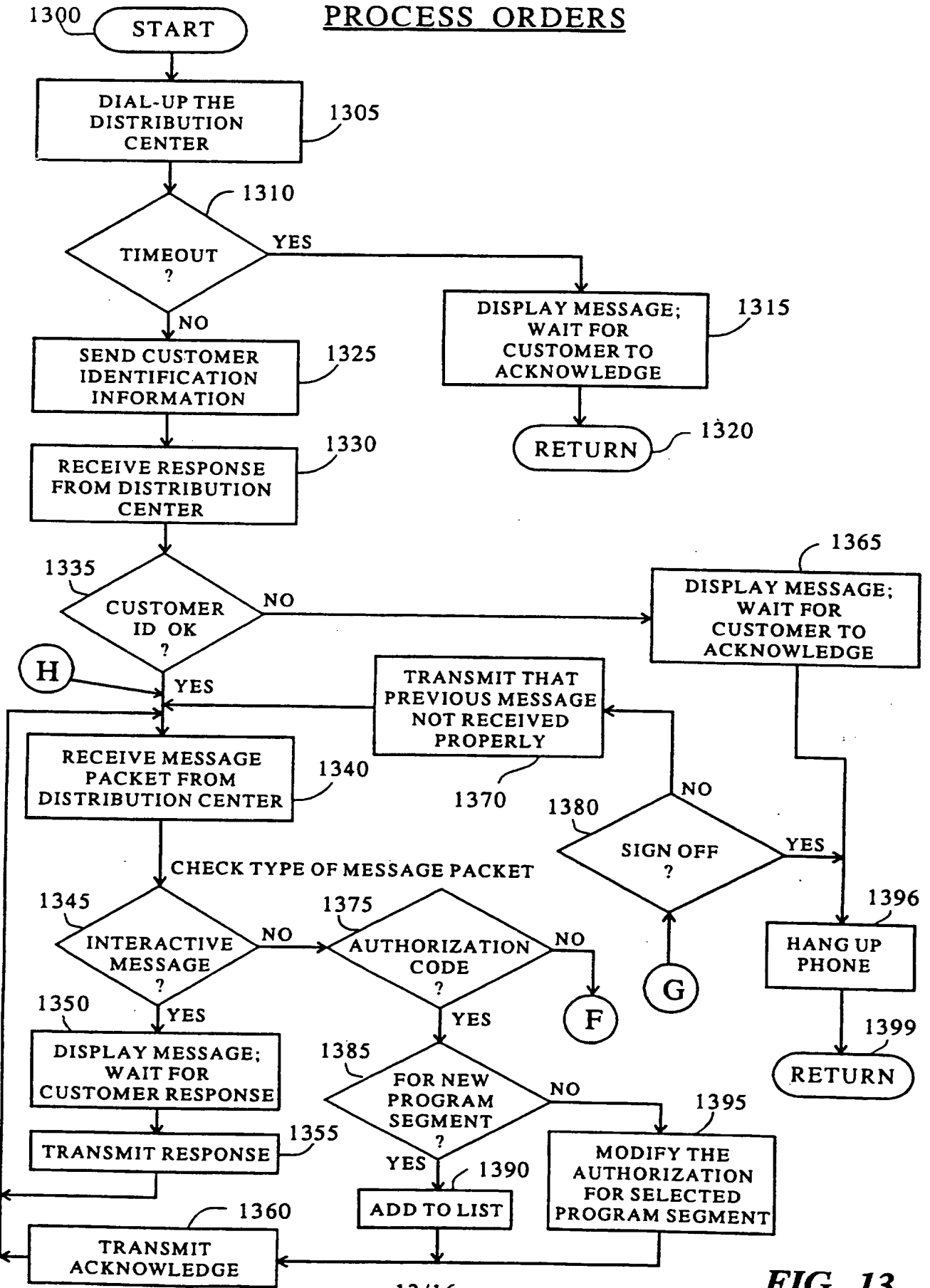

FIG. 13

PROCESS ORDERS (CONT.)

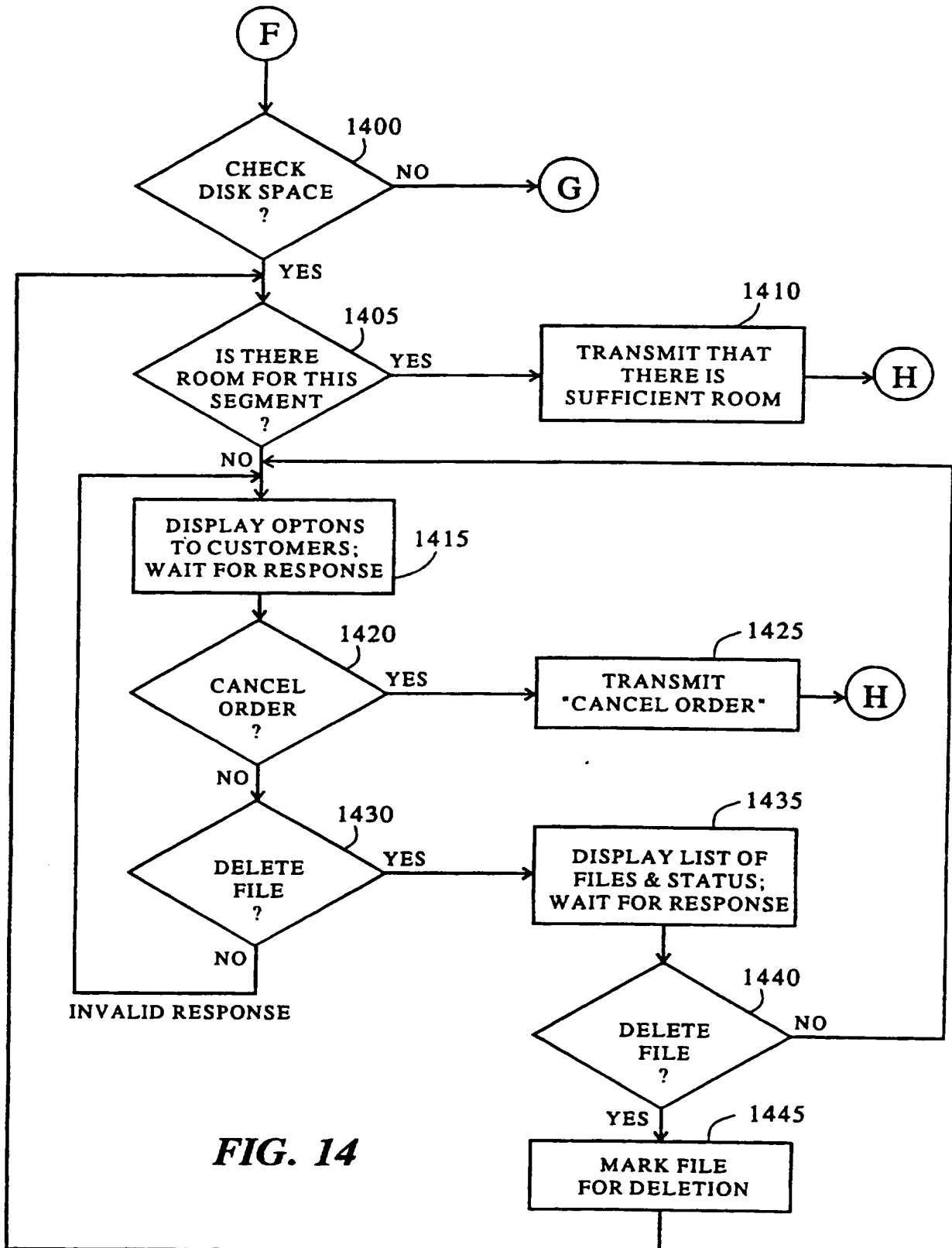

FIG. 14

SELECT VIEW

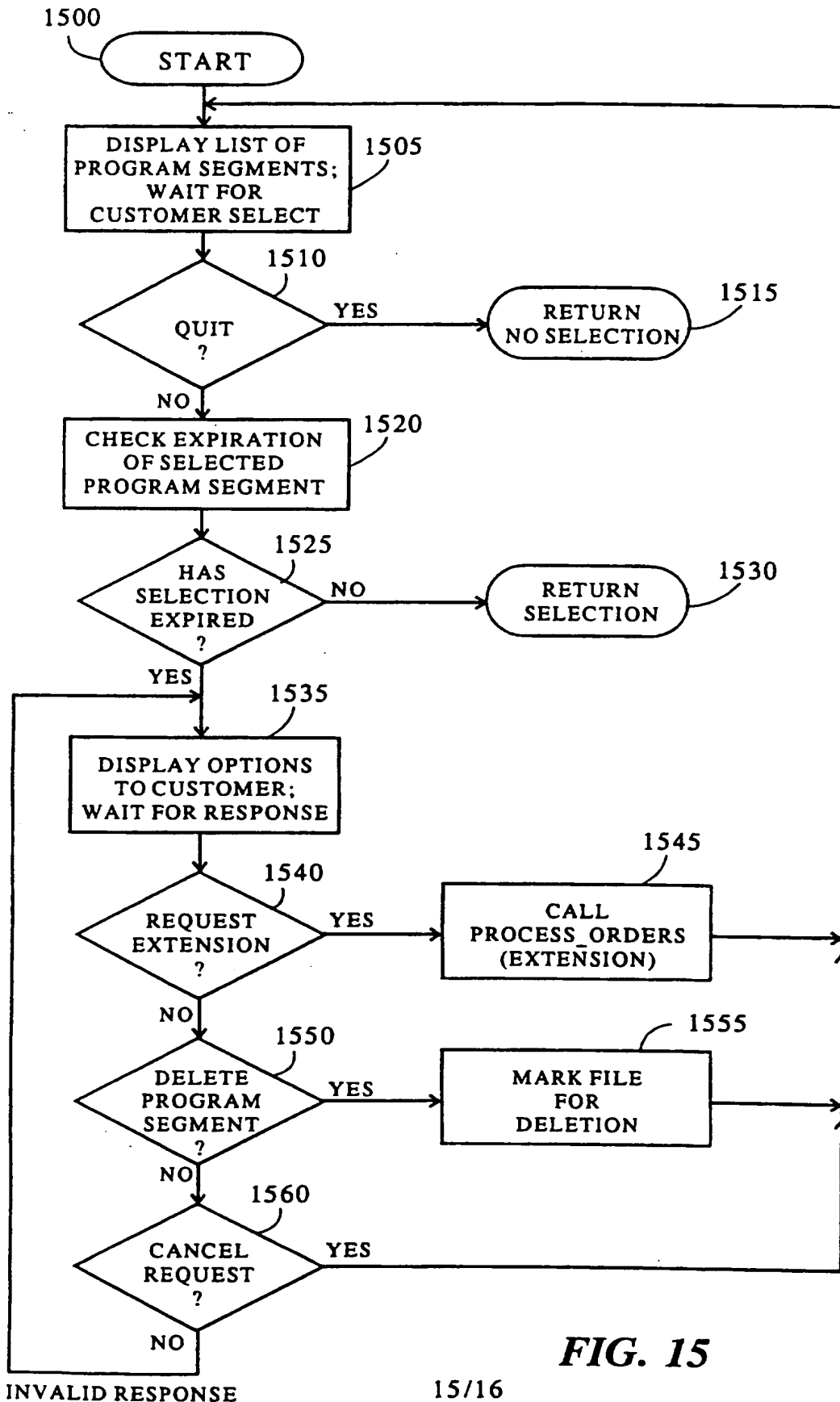

FIG. 15

VIEW MODULE

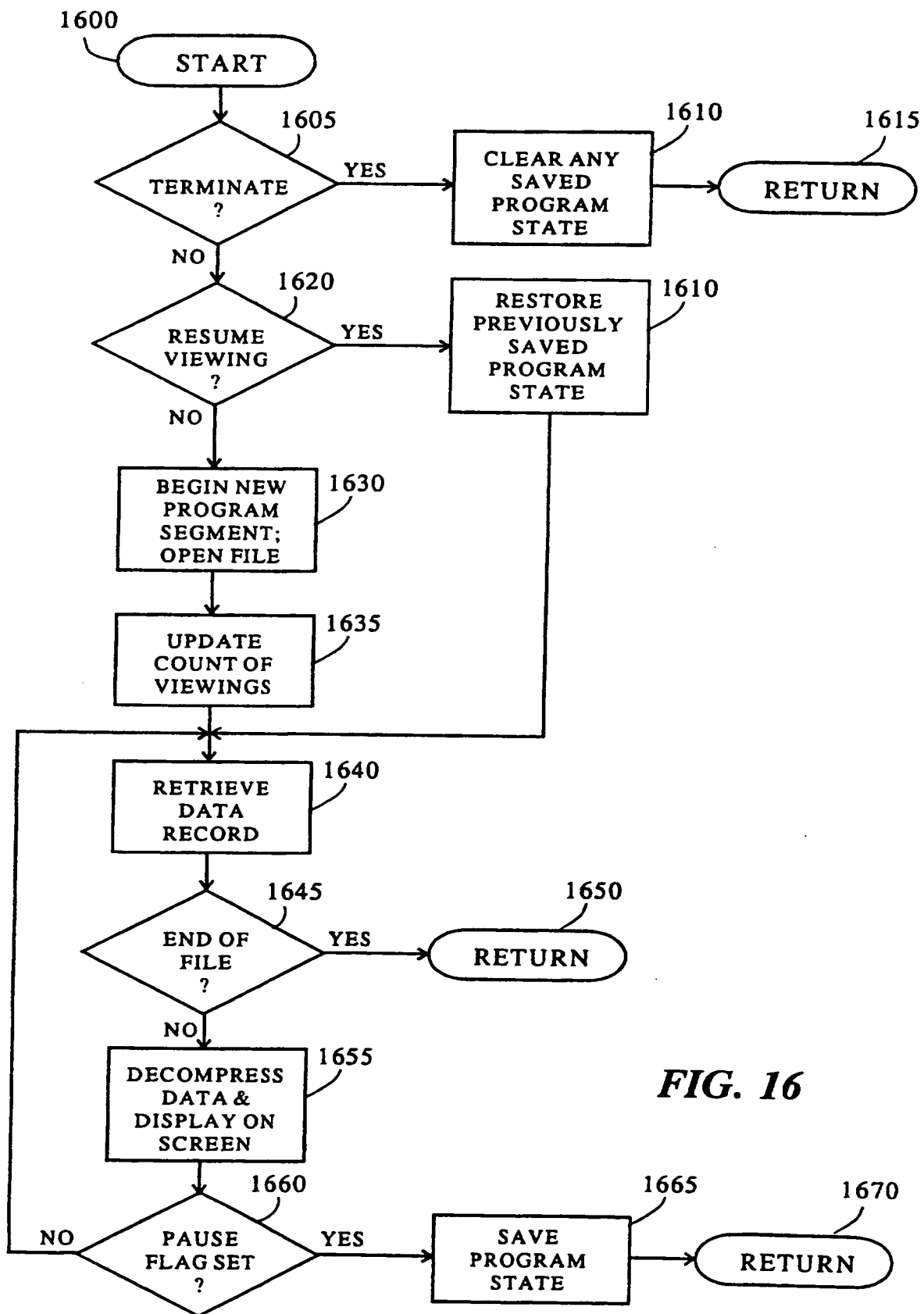

FIG. 16

INTERNATIONAL SEARCH REPORT

Internat. Application No
PCT/US 95/09802

A. CLASSIFICATION OF SUBJECT MATTER
IPC 6 H04N7/173

According to International Patent Classification (IPC) or to both national classification and IPC

B. FIELDS SEARCHED

Minimum documentation searched (classification system followed by classification symbols)
IPC 6 H04N

Documentation searched other than minimum documentation to the extent that such documents are included in the fields searched

Electronic data base consulted during the international search (name of data base and, where practical, search terms used)

C. DOCUMENTS CONSIDERED TO BE RELEVANT

Category	Citation of document, with indication, where appropriate, of the relevant passages	Relevant to claim No.
X	<p>COMMUNICATIONS - RISING TO THE HEIGHTS, DENVER, JUNE 23 - 26, 1991, vol. 2 OF 3, 23 June 1991 INSTITUTE OF ELECTRICAL AND ELECTRONICS ENGINEERS, pages 842-846, XP 000269608 GELMAN A D ET AL 'A STORE-AND-FORWARD ARCHITECTURE FOR VIDEO-ON-DEMAND SERVICE' see the whole document</p> <p style="text-align: center;">---</p>	<p>1,3-7, 9-11, 13-28</p>
X	<p>WO,A,92 12599 (YURT ET AL) 23 July 1992 see page 1, line 19 - line 21 see page 3, line 12 - page 4, line 27 see page 5, line 24 - page 14, line 25 see page 18, line 24 - page 21, line 26 see page 23, line 1 - page 26, line 36 see figures 1-8</p> <p style="text-align: center;">---</p> <p style="text-align: center;">-/--</p>	<p>1-28</p>

Further documents are listed in the continuation of box C.

Patent family members are listed in annex.

* Special categories of cited documents :

- *A* document defining the general state of the art which is not considered to be of particular relevance
- *E* earlier document but published on or after the international filing date
- *L* document which may throw doubts on priority claim(s) or which is cited to establish the publication date of another citation or other special reason (as specified)
- *O* document referring to an oral disclosure, use, exhibition or other means
- *P* document published prior to the international filing date but later than the priority date claimed

- *T* later document published after the international filing date or priority date and not in conflict with the application but cited to understand the principle or theory underlying the invention
- *X* document of particular relevance; the claimed invention cannot be considered novel or cannot be considered to involve an inventive step when the document is taken alone
- *Y* document of particular relevance; the claimed invention cannot be considered to involve an inventive step when the document is combined with one or more other such documents, such combination being obvious to a person skilled in the art.
- *&* document member of the same patent family

Date of the actual completion of the international search

12 January 1996

Date of mailing of the international search report

24. 01. 96

Name and mailing address of the ISA

European Patent Office, P.B. 5818 Patentlaan 2
NL - 2280 HV Rijswijk
Tel. (+ 31-70) 340-2040, Tx. 31 651 epo nl,
Fax: (+ 31-70) 340-3016

Authorized officer

Van der Zaal, R

INTERNATIONAL SEARCH REPORT

Internat J Application No
PCT/US 95/09802

C.(Continuation) DOCUMENTS CONSIDERED TO BE RELEVANT		
Category	Citation of document, with indication, where appropriate, of the relevant passages	Relevant to claim No.
X	<p>COMPUTER NETWORKS AND ISDN SYSTEMS, vol. 26, no. 10, July 1994 AMSTERDAM, NL, pages 1305-1322, XP 000453512 RAMANATHAN ET AL 'Towards personalized multimedia dial-up services' see page 1305, line 1 - page 1311, right column, line 41 see page 1313, left column, line 10 - page 1318, left column, line 19 see page 1319, right column, line 7 - page 1321, right column, line 27 see figures 1-3,5-8,11 ---</p>	<p>1-3, 7-11, 13-19, 24-28</p>
X	<p>EP,A,0 605 115 (AT&T) 6 July 1994</p> <p>see page 3, column 1, line 51 - page 4, column 3, line 19 see page 4, column 4, line 8 - page 14, column 23, line 35 see figures 1-11 -----</p>	<p>1,4, 7-19, 23-26</p>

INTERNATIONAL SEARCH REPORT

Information on patent family members

Intern: al Application No

PCT/US 95/09802

Patent document cited in search report	Publication date	Patent family member(s)	Publication date
WO-A-9212599	23-07-92	US-A- 5132992	21-07-92
		AU-B- 1197092	17-08-92
		EP-A- 0566662	27-10-93
		JP-T- 6501601	17-02-94
		US-A- 5253275	12-10-93
EP-A-605115	06-07-94	US-A- 5442389	15-08-95
		JP-A- 7177492	14-07-95

THIS PAGE BLANK (USPTO)